

# EZ Tube® CONNECT 20FT KIT A (5'X10'5')

PRODUCT CATEGORY: EZ FABRIC DISPLAYS

PRODUCT CODE: EZCNCT-20KIT-A-5X10X5



On frame On graphic



Single foot connection



Double foot connection

Foot Dims  
3 1/8" x 18 3/4"

## PRODUCT DESCRIPTION

Modular has officially met tube frames! EZ Tube® Connect modular tube display system lets you configure multiple shapes, sizes and frames. EZ Tube® Connect lets you choose from straight, round or slant top shapes, 90" or 96" frame heights, and 2ft, 3ft, 4ft, 5ft, 8ft and 10ft frame widths. Each EZ Tube® Connect frame easily connects, using aluminum tubing with push button snaps to lock and to attach to feet. Feet have two mounting points to connect frames side-by-side. Customize single- or double-sided stretch fabric graphics that pulls over frames and zips closed underneath. Medium Hard Case included. (Medium Hardcase Graphic optional)

DISPLAY DIMENSIONS	240"W x 90"H x 18.75"D
GRAPHIC SIZE 5FT	60.75"W x 89.5"H
GRAPHIC SIZE 10FT	121"W x 89.5"H
GRAPHIC SIZE MHC	62.375"W x 32.25"H

## GRAPHIC MATERIAL

Stretch Fabric

## GRAPHIC FINISHING

Sewn on left, right and top with zipper on the bottom

## DISPLAY CONSTRUCTION

34mm Aluminum Tubing

## SHIPPING WEIGHTS & DIMENSIONS

Shipping Weight	53 lbs (frames and graphics - case 1) 49 lbs (frames and graphics - case 2)
Shipping Dimensions	22"W x 39"H x 17"D (each case)

## LARGE QUANTITY FREIGHT

Freight Shipping	8 boxes per 48"L x 40"W x 43"H skid
Freight Weight	408 lbs (frames & graphics)

## GRAPHIC TURN AROUND TIME

2 business days after proof approval (up to 2 kits)

AVAILABILITY	Pacific Fulfillment Center
--------------	----------------------------



Connecting Clip



Includes qty 2 Medium Hard Case  
Case Inside Dimensions:  
20.5"W x 32.5"H x 12"D

# EZ Tube® CONNECT 20FT KIT A (5'X10'5')

PRODUCT CATEGORY: EZ FABRIC DISPLAYS

PRODUCT CODE: EZCNCT-20KIT-A-5X10X5

## PARTS LIST



Top cross bar-2ft slope  
(qty 2)

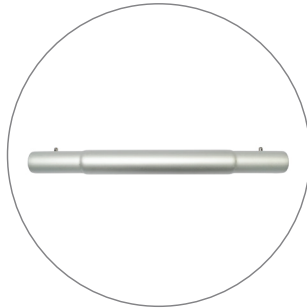

Bottom cross bar-2ft  
(qty 2)



Top cross bar-5ft slope  
(qty 1)

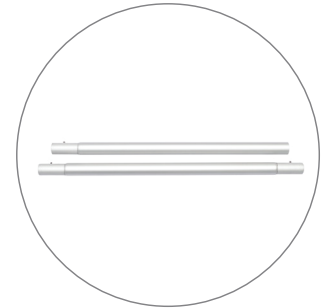

Bottom cross bar-5ft  
(qty 1)

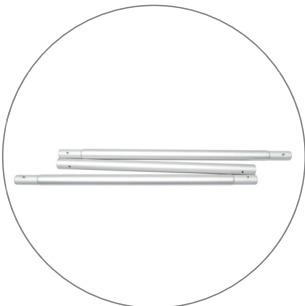

3 section 64" pole  
(qty 6)

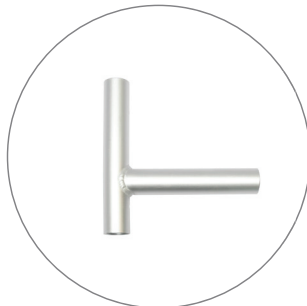

Bottom Cross Bar L  
shape connector  
(qty 6)



Single Foot (34mm)  
(qty 2)



Double Foot (34mm)  
(qty 2)



MHC  
(qty 2)



Soft Bag 2ft  
(qty 2)



Soft Bag 5ft  
(qty 1)



Connecting Clip  
(qty 4)

# EZ Tube® CONNECT 20FT KIT B (8'X4'X8')

PRODUCT CATEGORY: EZ FABRIC DISPLAYS

PRODUCT CODE: EZCNCT-20KIT-B-8X4X8



On frame On graphic

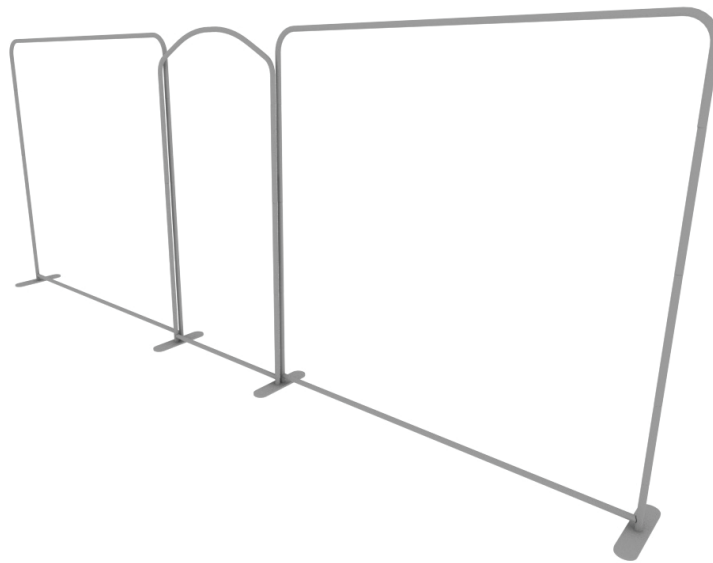

## PRODUCT DESCRIPTION

Modular has officially met tube frames! EZ Tube® Connect modular tube display system lets you configure multiple shapes, sizes and frames. EZ Tube® Connect lets you choose from straight, round or slant top shapes, 90" or 96" frame heights, and 2ft, 3ft, 4ft, 5ft, 8ft and 10ft frame widths. Each EZ Tube® Connect frame easily connects, using aluminum tubing with push button snaps to lock and to attach to feet. Feet have two mounting points to connect frames side-by-side. Customize single- or double-sided stretch fabric graphics that pulls over frames and zips closed underneath. Medium Hard Case included. (Medium Hardcase Graphic optional)

DISPLAY DIMENSIONS	240"W x 90"H x 18.75"D
GRAPHIC SIZE 4FT	49"W x 89.5"H
GRAPHIC SIZE 8FT	96.5"W x 89.5"H
GRAPHIC SIZE MHC	62.375"W x 32.25"H

## GRAPHIC MATERIAL

Stretch Fabric

## GRAPHIC FINISHING

Sewn on left, right and top with zipper on the bottom

## DISPLAY CONSTRUCTION

34mm Aluminum Tubing

## SHIPPING WEIGHTS & DIMENSIONS

Shipping Weight	57 lbs (frames and graphics - case 1) 48 lbs (frames and graphics - case 2)
Shipping Dimensions	22"W x 39"H x 17"D (each case)

## LARGE QUANTITY FREIGHT

Freight Shipping	8 boxes per 48"L x 40"W x 43"H skid
Freight Weight	420 lbs (frames & graphics - 4 sets)

## GRAPHIC TURN AROUND TIME

2 business days after proof approval (up to 2 kits)

AVAILABILITY	Pacific Fulfillment Center
--------------	----------------------------



Connecting Clip



Single foot connection



Double foot connection

Foot Dims  
3 1/8" x 18 3/4"



Includes qty 2 Medium Hard Case  
Case Inside Dimensions:  
20.5"W x 32.5"H x 12"D

# EZ Tube® CONNECT 20FT KIT B (8'X4'X8')

PRODUCT CATEGORY: EZ FABRIC DISPLAYS

PRODUCT CODE: EZCNCT-20KIT-B-8X4X8

## PARTS LIST



Top cross bar-8ft straight  
(qty 2)

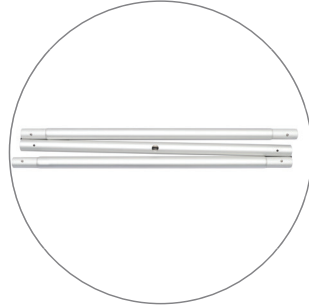

Bottom cross bar-8ft  
(qty 2)



Top cross bar-4ft round  
(qty 1)

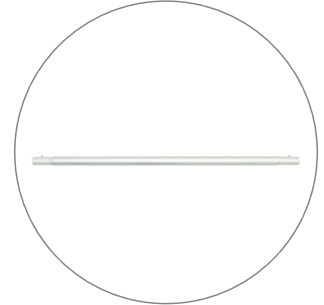

Bottom cross bar-4ft  
(qty 1)



3 section 64" pole  
(qty 6)



Bottom Cross Bar L  
shape connector  
(qty 6)



Single Foot (34mm)  
(qty 2)

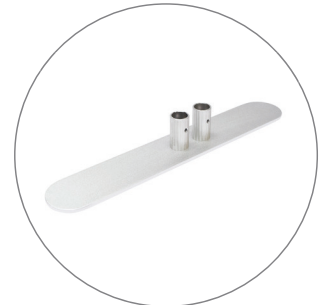

Double Foot (34mm)  
(qty 2)

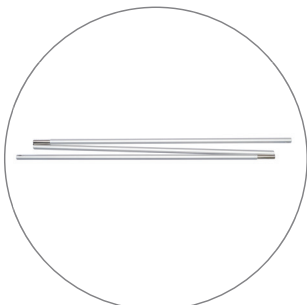

Center Vertical pole-90"  
(qty 2)



MHC  
(qty 2)



Soft Bag 8ft  
(qty 2)



Soft Bag 4ft  
(qty 1)



Connecting Clip  
(qty 4)



# EZ Tube® CONNECT 20FT KIT C (5'X5'X5'X5')

PRODUCT CATEGORY: EZ FABRIC DISPLAYS  
 PRODUCT CODE: EZCNCT-20KIT-C-5X5X5X5



On frame On graphic



## PRODUCT DESCRIPTION

Modular has officially met tube frames! EZ Tube® Connect modular tube display system lets you configure multiple shapes, sizes and frames. EZ Tube® Connect lets you choose from straight, round or slant top shapes, 90" or 96" frame heights, and 2ft, 3ft, 4ft, 5ft, 8ft and 10ft frame widths. Each EZ Tube® Connect frame easily connects, using aluminum tubing with push button snaps to lock and to attach to feet. Feet have two mounting points to connect frames side-by-side. Customize single- or double-sided stretch fabric graphics that pulls over frames and zips closed underneath. Medium Hard Case included. (Medium Hardcase Graphic optional)

DISPLAY DIMENSIONS	240"W x 90"H x 18.75"D
GRAPHIC SIZE STRAIGHT	60.75"W x 88.5"H
GRAPHIC SIZE CURVED	60.75"W x 89.5"H
GRAPHIC SIZE MHC	62.375"W x 32.25"H

## GRAPHIC MATERIAL

Stretch Fabric

## GRAPHIC FINISHING

Sewn on left, right and top with zipper on the bottom

## DISPLAY CONSTRUCTION

34mm Aluminum Tubing

## SHIPPING WEIGHTS & DIMENSIONS

Shipping Weight	53 lbs (frames & graphics - each case) 2 cases total
Shipping Dimensions	22"W x 39"H x 17"D (each case)

## LARGE QUANTITY FREIGHT

Freight Shipping	8 boxes per 48"L x 40"W x 43"H skid
Freight Weight	424 lbs (frames & graphics - 4 sets)

## GRAPHIC TURN AROUND TIME

2 business days after proof approval (up to 2 kits)

AVAILABILITY	Pacific Fulfillment Center
--------------	----------------------------

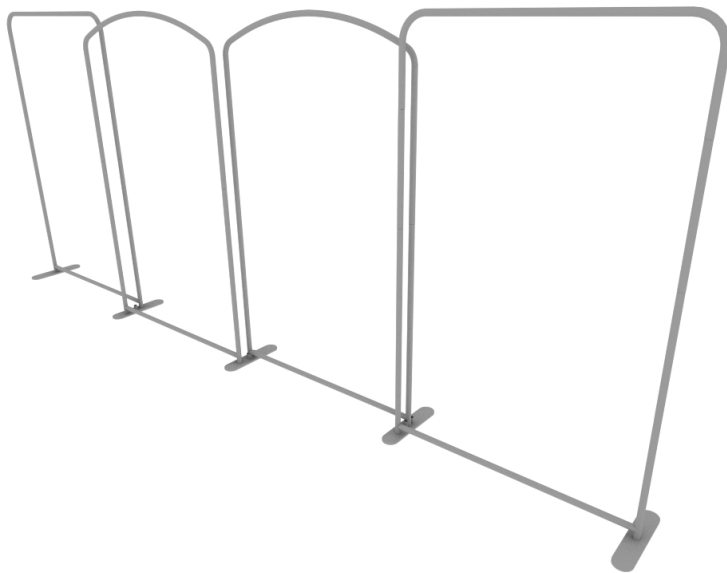

Connecting Clip



Single foot connection



Double foot connection

Foot Dims  
3 1/8" x 18 3/4"



Includes qty 2 Medium Hard Case  
 Case Inside Dimensions:  
 20.5"W x 32.5"H x 12"D

# EZ Tube® CONNECT 20FT KIT C (5'X5'X5'X5')

PRODUCT CATEGORY: EZ FABRIC DISPLAYS

PRODUCT CODE: EZCNCT-20KIT-C-5X5X5X5

## PARTS LIST



Top cross bar-5ft straight  
(qty 2)

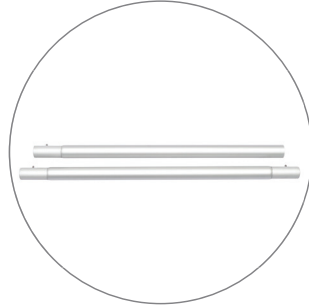

Bottom cross bar-5ft  
(qty 4)



Top cross bar-5ft round  
(qty 2)



3 section 64" pole  
(qty 4)

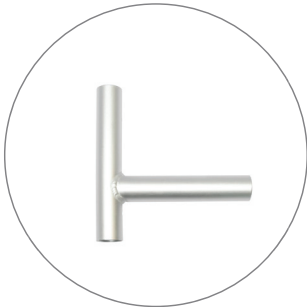

Bottom Cross Bar L shape  
connector  
(qty 8)



Single Foot (34mm)  
(qty 2)



Double Foot (34mm)  
(qty 3)



MHC  
(qty 2)



Soft Bag 5ft  
(qty 4)



Connecting Clip  
(qty 6)

# EZ Tube® CONNECT 20FT KIT D (5'X5'X5'X5')

PRODUCT CATEGORY: EZ FABRIC DISPLAYS  
 PRODUCT CODE: EZCNCT-20KIT-D-5X5X5X5



On frame On graphic

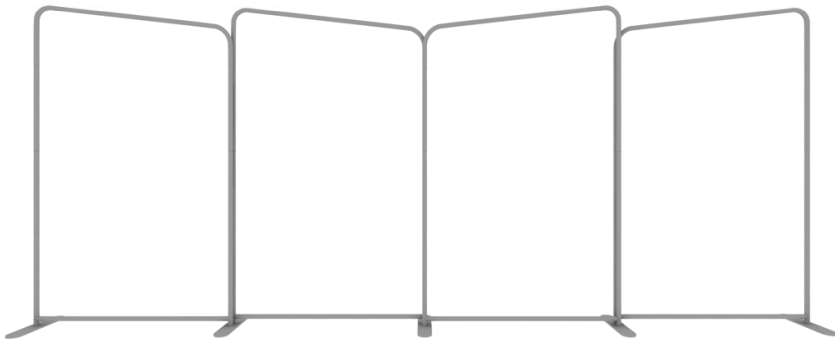
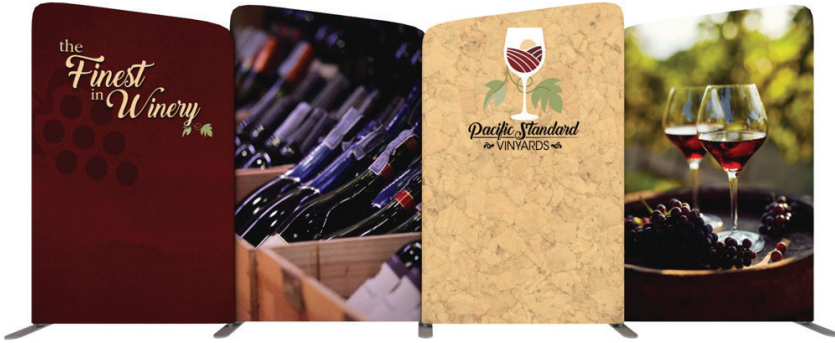

## PRODUCT DESCRIPTION

Modular has officially met tube frames! EZ Tube® Connect modular tube display system lets you configure multiple shapes, sizes and frames. EZ Tube® Connect lets you choose from straight, round or slant top shapes, 90" or 96" frame heights, and 2ft, 3ft, 4ft, 5ft, 8ft and 10ft frame widths. Each EZ Tube® Connect frame easily connects, using aluminum tubing with push button snaps to lock and to attach to feet. Feet have two mounting points to connect frames side-by-side. Customize single- or double-sided stretch fabric graphics that pulls over frames and zips closed underneath. Medium Hard Case included. (Medium Hardcase Graphic optional)

DISPLAY DIMENSIONS	240"W x 90"H x 18.75"D
GRAPHIC SIZE 5FT	60.75"W x 89.5"H
GRAPHIC SIZE MHC	62.375"W x 32.25"H

## GRAPHIC MATERIAL

Stretch Fabric

## GRAPHIC FINISHING

Sewn on left, right and top with zipper on the bottom

## DISPLAY CONSTRUCTION

34mm Aluminum Tubing

## SHIPPING WEIGHTS & DIMENSIONS

Shipping Weight	53 lbs (frames & graphics - each case) 2 cases total
Shipping Dimensions	22"W x 39"H x 17"D (each case)

## LARGE QUANTITY FREIGHT

Freight Shipping	8 boxes per 48"L x 40"W x 43"H skid
Freight Weight	424 lbs (frames & graphics - 4 sets)

## GRAPHIC TURN AROUND TIME

2 business days after proof approval (up to 2 kits)

AVAILABILITY	Pacific Fulfillment Center
--------------	----------------------------



Connecting Clip



Single foot connection



Double foot connection

Foot Dims  
3 1/8" x 18 3/4"



Includes qty 2 Medium Hard Case  
 Case Inside Dimensions:  
 20.5"W x 32.5"H x 12"D

# EZ Tube® CONNECT 20FT KIT D (5'X5'X5'X5')

PRODUCT CATEGORY: EZ FABRIC DISPLAYS

PRODUCT CODE: EZCNCT-20KIT-D-5X5X5X5

## PARTS LIST



Top cross bar-5ft slope  
(qty 4)

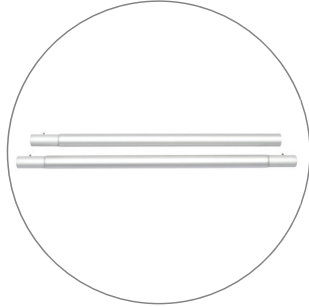

Bottom cross bar-5ft  
(qty 4)



3 section 64" pole  
(qty 4)

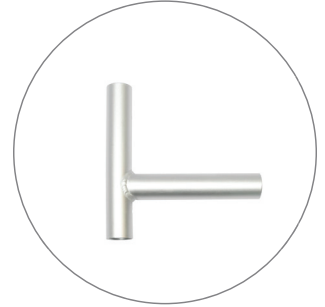

Bottom Cross Bar L shape  
connector  
(qty 8)



Single Foot (34mm)  
(qty 2)



Double Foot (34mm)  
(qty 4)



MHC  
(qty 2)



Soft Bag 5ft  
(qty 4)



Connecting Clip  
(qty 6)



# EZ Tube® CONNECT 20FT KIT E (8'X4'8')

PRODUCT CATEGORY: EZ FABRIC DISPLAYS

PRODUCT CODE: EZCNCT-20KIT-E-8X4X8



On frame On graphic

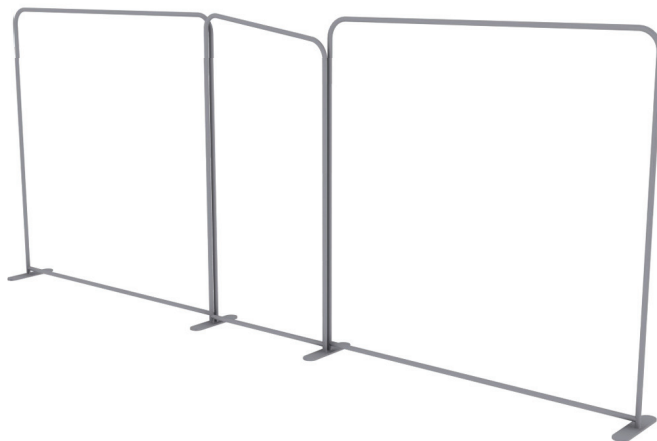

Single foot connection



Double foot connection

Foot Dims  
3 1/8" x 18 3/4"

## PRODUCT DESCRIPTION

Modular has officially met tube frames! EZ Tube® Connect modular tube display system lets you configure multiple shapes, sizes and frames. EZ Tube® Connect lets you choose from straight, round or slant top shapes, 90" or 96" frame heights, and 2ft, 3ft, 4ft, 5ft, 8ft and 10ft frame widths. Each EZ Tube® Connect frame easily connects, using aluminum tubing with push button snaps to lock and to attach to feet. Feet have two mounting points to connect frames side-by-side. Customize single- or double-sided stretch fabric graphics that pulls over frames and zips closed underneath. Medium Hard Case included. (Medium Hardcase Graphic optional)

DISPLAY DIMENSIONS	240"W x 90"H x 18.75"D
GRAPHIC SIZE 4FT	49"W x 89.5"H
GRAPHIC SIZE 8FT	96.5"W x 89.5"H
GRAPHIC SIZE MHC	62.375"W x 32.25"H

## GRAPHIC MATERIAL

Stretch Fabric

## GRAPHIC FINISHING

Sewn on left, right and top with zipper on the bottom

## DISPLAY CONSTRUCTION

34mm Aluminum Tubing

## SHIPPING WEIGHTS & DIMENSIONS

Shipping Weight	57 lbs (frames and graphics - case 1) 48 lbs (frames and graphics - case 2)
Shipping Dimensions	22"W x 39"H x 17"D (each case)

## LARGE QUANTITY FREIGHT

Freight Shipping	8 boxes per 48"L x 40"W x 43"H skid
Freight Weight	420 lbs (frames & graphics)

## GRAPHIC TURN AROUND TIME

2 business days after proof approval (up to 2 kits)

AVAILABILITY	Pacific Fulfillment Center
--------------	----------------------------



Connecting Clip



Includes qty 2 Medium Hard Case  
Case Inside Dimensions:  
20.5"W x 32.5"H x 12"D



# EZ Tube® CONNECT 20FT KIT E (8'X4'8')

PRODUCT CATEGORY: EZ FABRIC DISPLAYS

PRODUCT CODE: EZCNCT-20KIT-E-8X4X8

## PARTS LIST

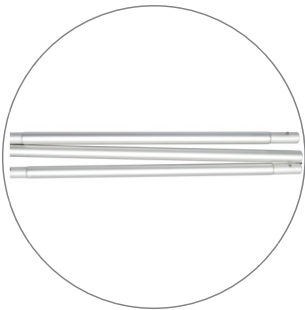

Top cross bar-8ft straight  
(qty 2)



Bottom cross bar-8ft  
(qty 2)



Top cross bar-4ft slope  
(qty 1)

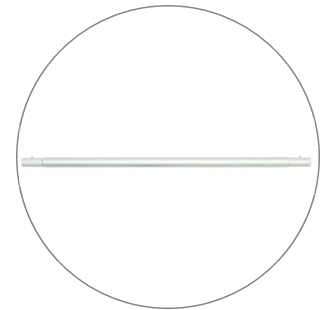

Bottom cross bar-4ft  
(qty 1)



3 section 64" pole  
(qty 6)



Bottom Cross Bar L  
shape connector  
(qty 6)



Single Foot (34mm)  
(qty 2)



Double Foot (34mm)  
(qty 2)

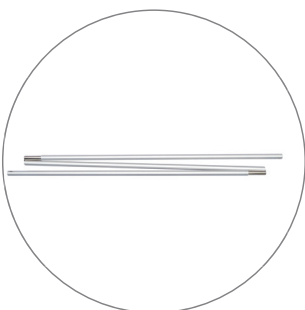

Center Vertical pole-90"  
(qty 1)



MHC  
(qty 2)



Soft Bag 8ft  
(qty 2)



Soft Bag 4ft  
(qty 1)



Connecting Clip  
(qty 4)

# EZ Tube® CONNECT 20FT KIT F (8'X4'8')

PRODUCT CATEGORY: EZ FABRIC DISPLAYS  
 PRODUCT CODE: EZCNCT-20KIT-F-8X4X8



On frame On graphic

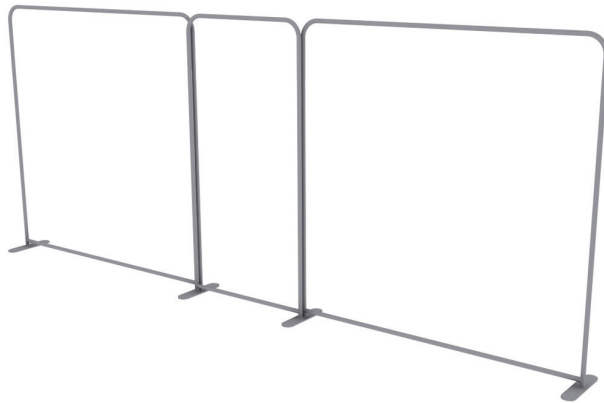

Single foot connection



Double foot connection

Foot Dims  
 3 1/8" x 18 3/4"

## PRODUCT DESCRIPTION

Modular has officially met tube frames! EZ Tube® Connect modular tube display system lets you configure multiple shapes, sizes and frames. EZ Tube® Connect lets you choose from straight, round or slant top shapes, 90" or 96" frame heights, and 2ft, 3ft, 4ft, 5ft, 8ft and 10ft frame widths. Each EZ Tube® Connect frame easily connects, using aluminum tubing with push button snaps to lock and to attach to feet. Feet have two mounting points to connect frames side-by-side. Customize single- or double-sided stretch fabric graphics that pulls over frames and zips closed underneath. Medium Hard Case included. (Medium Hardcase Graphic optional)

DISPLAY DIMENSIONS	240"W x 90"H x 18.75"D
GRAPHIC SIZE 4FT	49"W x 89.5"H
GRAPHIC SIZE 8FT	96.5"W x 89.5"H
GRAPHIC SIZE MHC	62.375"W x 32.25"H

## GRAPHIC MATERIAL

Stretch Fabric

## GRAPHIC FINISHING

Sewn on left, right and top with zipper on the bottom

## DISPLAY CONSTRUCTION

34mm Aluminum Tubing

## SHIPPING WEIGHTS & DIMENSIONS

Shipping Weight	57 lbs (frames and graphics - case 1) 48 lbs (frames and graphics - case 2)
Shipping Dimensions	22"W x 39"H x 17"D (each case)

## LARGE QUANTITY FREIGHT

Freight Shipping	8 boxes per 48"L x 40"W x 43"H skid
Freight Weight	420 lbs (frames & graphics)

## GRAPHIC TURN AROUND TIME

2 business days after proof approval (up to 2 kits)

AVAILABILITY	Pacific Fulfillment Center
--------------	----------------------------



Connecting Clip



Includes qty 2 Medium Hard Case  
 Case Inside Dimensions:  
 20.5"W x 32.5"H x 12"D

# EZ Tube® CONNECT 20FT KIT F (8'X4'8')

PRODUCT CATEGORY: EZ FABRIC DISPLAYS

PRODUCT CODE: EZCNCT-20KIT-F-8X4X8

## PARTS LIST

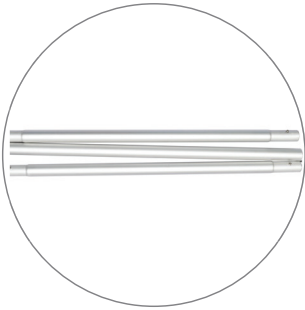

Top cross bar-8ft straight  
(qty 2)



Bottom cross bar-8ft  
(qty 2)

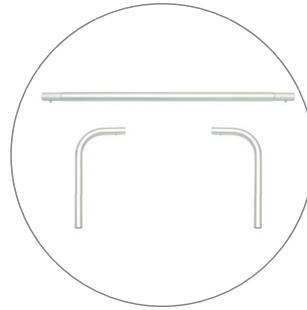

Top cross bar-4ft straight  
(qty 1)

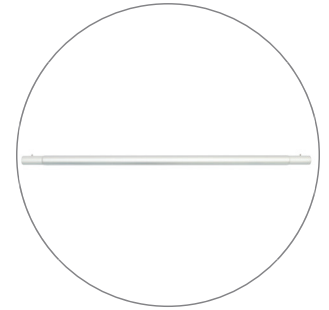

Bottom cross bar-4ft  
(qty 1)



3 section 64" pole  
(qty 6)

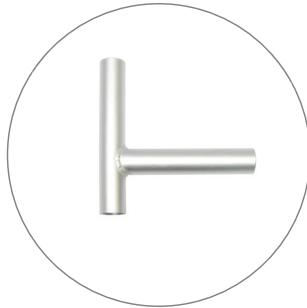

Bottom Cross Bar L  
shape connector  
(qty 6)



Single Foot (34mm)  
(qty 2)



Double Foot (34mm)  
(qty 2)

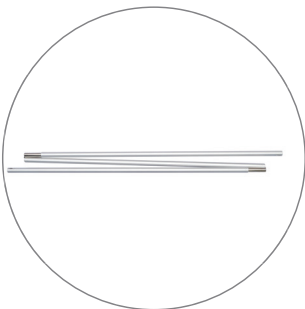

Center Vertical pole-90"  
(qty 1)



MHC  
(qty 2)



Soft Bag 8ft  
(qty 2)



Soft Bag 4ft  
(qty 1)



Connecting Clip  
(qty 4)

# EZ Tube® CONNECT 20FT KIT G (5'X5'X5'X5')

PRODUCT CATEGORY: EZ FABRIC DISPLAYS  
 PRODUCT CODE: EZCNCT-20KIT-G-5X5X5X5



On frame On graphic

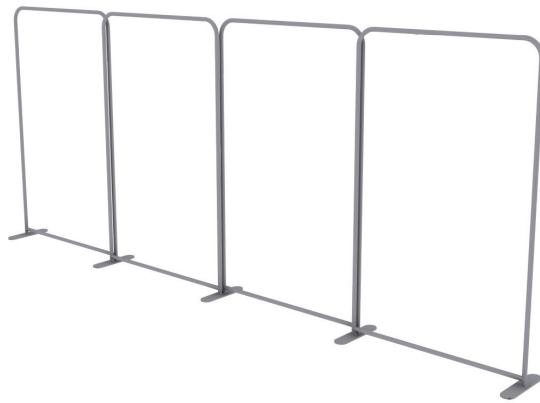

Single foot connection



Double foot connection

Foot Dims  
 3 1/8" x 18 3/4"

## PRODUCT DESCRIPTION

Modular has officially met tube frames! EZ Tube® Connect modular tube display system lets you configure multiple shapes, sizes and frames. EZ Tube® Connect lets you choose from straight, round or slant top shapes, 90" or 96" frame heights, and 2ft, 3ft, 4ft, 5ft, 8ft and 10ft frame widths. Each EZ Tube® Connect frame easily connects, using aluminum tubing with push button snaps to lock and to attach to feet. Feet have two mounting points to connect frames side-by-side. Customize single- or double-sided stretch fabric graphics that pulls over frames and zips closed underneath. (Medium Hardcase Graphic optional)

DISPLAY DIMENSIONS	240"W x 90"H x 18.75"D
GRAPHIC SIZE	60.75"W x 88.5"H
GRAPHIC SIZE MHC	62.375"W x 32.25"H

## GRAPHIC MATERIAL

Stretch Fabric

## GRAPHIC FINISHING

Sewn on left, right and top with zipper on the bottom

## DISPLAY CONSTRUCTION

34mm Aluminum Tubing

## SHIPPING WEIGHTS & DIMENSIONS

Shipping Weight	53 lbs (frames & graphics - each case) 2 cases total
Shipping Dimensions	22"W x 39"H x 17"D (each case)

## LARGE QUANTITY FREIGHT

Freight Shipping	8 boxes per 48"L x 40"W x 43"H skid
Freight Weight	424 lbs (frames & graphics - 4 sets)

## GRAPHIC TURN AROUND TIME

2 business days after proof approval (up to 2 kits)

AVAILABILITY	Pacific Fulfillment Center
--------------	----------------------------



Connecting Clip



Includes qty 2 Medium Hard Case  
 Case Inside Dimensions:  
 20.5"W x 32.5"H x 12"D



# EZ Tube® CONNECT 20FT KIT G (5'X5'X5'X5')

PRODUCT CATEGORY: EZ FABRIC DISPLAYS

PRODUCT CODE: EZCNCT-20KIT-G-5X5X5X5

## PARTS LIST

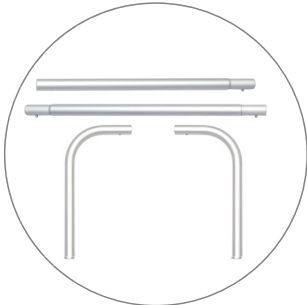

Top cross bar-5ft straight  
(qty 4)

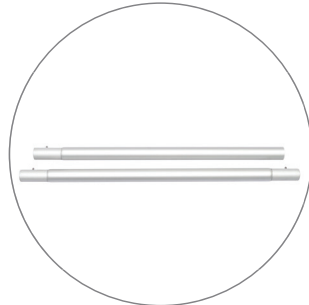

Bottom cross bar-5ft  
(qty 4)



3 section 64" pole  
(qty 4)



Bottom Cross Bar L shape  
connector  
(qty 8)



Connecting Clip  
(qty 6)



Single Foot (34mm)  
(qty 2)



Double Foot (34mm)  
(qty 3)



MHC  
(qty 2)



Soft Bag 5ft  
(qty 4)



# EZ Tube® CONNECT 20FT KIT H (5'X5'X5'X5')

PRODUCT CATEGORY: EZ FABRIC DISPLAYS  
 PRODUCT CODE: EZCNCT-20KIT-H-5X5X5X5



On frame On graphic

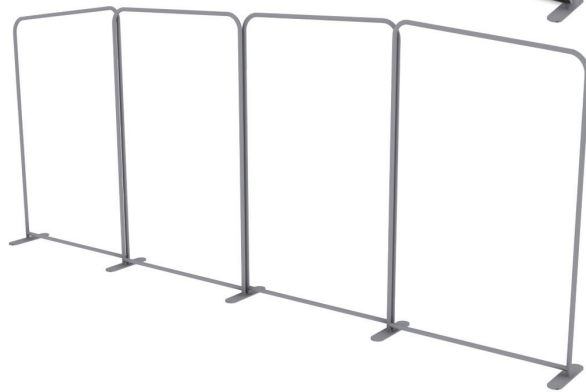

## PRODUCT DESCRIPTION

Modular has officially met tube frames! EZ Tube® Connect modular tube display system lets you configure multiple shapes, sizes and frames. EZ Tube® Connect lets you choose from straight, round or slant top shapes, 90" or 96" frame heights, and 2ft, 3ft, 4ft, 5ft, 8ft and 10ft frame widths. Each EZ Tube® Connect frame easily connects, using aluminum tubing with push button snaps to lock and to attach to feet. Feet have two mounting points to connect frames side-by-side. Customize single- or double-sided stretch fabric graphics that pulls over frames and zips closed underneath. Medium Hard Case included. (Medium Hardcase Graphic optional)

DISPLAY DIMENSIONS	240"W x 90"H x 18.75"D
GRAPHIC SIZE 5FT	60.75"W x 89.5"H
GRAPHIC SIZE MHC	62.375"W x 32.25"H

## GRAPHIC MATERIAL

Stretch Fabric

## GRAPHIC FINISHING

Sewn on left, right and top with zipper on the bottom

## DISPLAY CONSTRUCTION

34mm Aluminum Tubing

## SHIPPING WEIGHTS & DIMENSIONS

Shipping Weight	53 lbs (frames & graphics - each case) 2 cases total
Shipping Dimensions	22"W x 39"H x 17"D (each case)

## LARGE QUANTITY FREIGHT

Freight Shipping	8 boxes per 48"L x 40"W x 43"H skid
Freight Weight	424 lbs (frames & graphics - 4 sets)

## GRAPHIC TURN AROUND TIME

2 business days after proof approval (up to 2 kits)

AVAILABILITY	Pacific Fulfillment Center
--------------	----------------------------



Connecting Clip



Single foot connection



Double foot connection

Foot Dims  
3 1/8" x 18 3/4"



Includes qty 2 Medium Hard Case  
 Case Inside Dimensions:  
 20.5"W x 32.5"H x 12"D

# EZ Tube® CONNECT 20FT KIT H (5'X5'X5'X5')

PRODUCT CATEGORY: EZ FABRIC DISPLAYS

PRODUCT CODE: EZCNCT-20KIT-H-5X5X5X5

## PARTS LIST



Top cross bar-5ft slope  
(qty 2)



Top cross bar-5ft straight  
(qty 2)

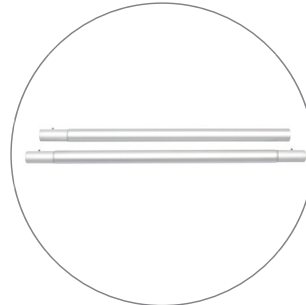

Bottom cross bar-5ft  
(qty 4)



3 section 64" pole  
(qty 4)

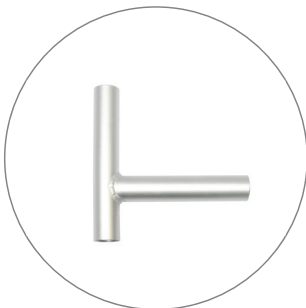

Bottom Cross Bar L shape  
connector  
(qty 8)



Single Foot (34mm)  
(qty 2)



Double Foot (34mm)  
(qty 3)



MHC  
(qty 2)



Connecting Clip  
(qty 6)



Soft Bag 5ft  
(qty 4)

# EZ Tube® CONNECT 20FT KIT I (8'X7'X8')

PRODUCT CATEGORY: EZ FABRIC DISPLAYS

PRODUCT CODE: EZCNCT-20KIT-I-8X7X8



On frame



On graphic

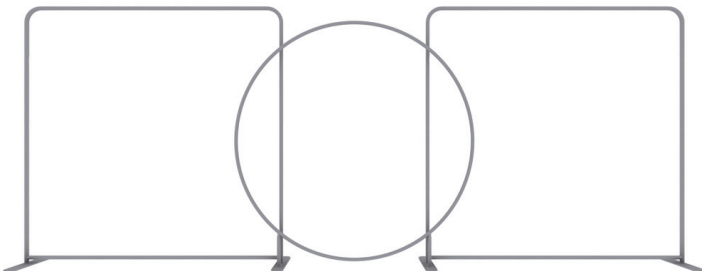

Single foot connection



Double foot connection

Foot Dims  
3 1/8" x 18 3/4"

## PRODUCT DESCRIPTION

Modular has officially met tube frames! EZ Tube® Connect modular tube display system lets you configure multiple shapes, sizes and frames. EZ Tube® Connect lets you choose from straight, round or slant top shapes, 90" or 96" frame heights, and 2ft, 3ft, 4ft, 5ft, 8ft and 10ft frame widths. Each EZ Tube® Connect frame easily connects, using aluminum tubing with push button snaps to lock and to attach to feet. Feet have two mounting points to connect frames side-by-side. Customize single- or double-sided stretch fabric graphics that pulls over frames and zips closed underneath. Medium Hard Case included. (Medium Hardcase Graphic optional)

DISPLAY DIMENSIONS	240"W x 90"H x 18.75"D
GRAPHIC SIZE 8FT	96.5"W x 89.5"H
GRAPHIC SIZE CIRCLE	61" W x 61" H
GRAPHIC SIZE MHC	62.375"W x 32.25"H

## GRAPHIC MATERIAL

Stretch Fabric

## GRAPHIC FINISHING

Sewn on left, right and top with zipper on the bottom

## DISPLAY CONSTRUCTION

34mm Aluminum Tubing

## SHIPPING WEIGHTS & DIMENSIONS

Shipping Weight	52 lbs (frames, graphics, MHC) Case 1 52 lbs (frames, graphics, MHC) Case 2 40 lbs (frames, graphics, MHC) Case 3
Shipping Dimensions	22"W x 39"H x 17"D Each Case

## LARGE QUANTITY FREIGHT

Freight Shipping	6 boxes per 48"L x 40"W x 43"H skid
Freight Weight	288 lbs (2 sets)

## GRAPHIC TURN AROUND TIME

2 business days after proof approval (up to 2 kits)

AVAILABILITY	Pacific Fulfillment Center
--------------	----------------------------



Includes qty 3 Medium Hard Case  
Case Inside Dimensions:  
20.5"W x 32.5"H x 12"D

# EZ Tube® CONNECT 20FT KIT I (8'X7'X8')

PRODUCT CATEGORY: EZ FABRIC DISPLAYS

PRODUCT CODE: EZCNCT-20KIT-I-8X7X8

## PARTS LIST



Top cross bar-8ft straight  
(qty 2)



Bottom cross bar-8ft  
(qty 2)



3 section 64" pole  
(qty 4)

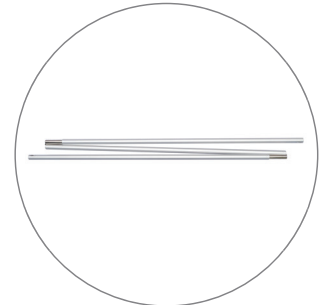

Center Vertical pole-90"  
(qty 2)



Bottom Cross Bar L shape  
connector  
(qty 4)

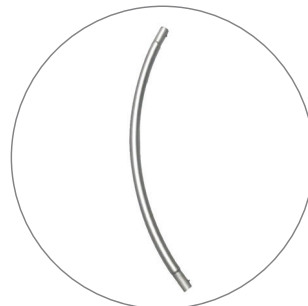

Male - Male Curved Tube  
(qty 2)

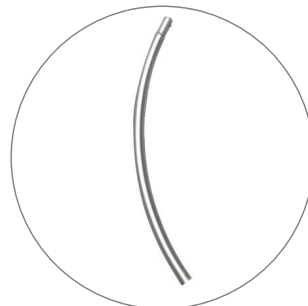

Male - Female Curved Tube  
(qty 5)



Bottom Tubes for Legs  
(qty 2)



Single Foot (34mm)  
(qty 2)



Double Foot (34mm)  
(qty 2)



Soft Bag 8ft  
(qty 2)



Soft Bag 7ft  
(qty 1)



MHC  
(qty 3)



# EZ Tube® CONNECT 20FT KIT J (4'X7'X4X7'X4')

PRODUCT CATEGORY: EZ FABRIC DISPLAYS  
 PRODUCT CODE: EZCNCT-20KIT-J-4X7X4X7X4



On frame



On graphic



## PRODUCT DESCRIPTION

Modular has officially met tube frames! EZ Tube® Connect modular tube display system lets you configure multiple shapes, sizes and frames. EZ Tube® Connect lets you choose from straight, round or slant top shapes, 90" or 96" frame heights, and 2ft, 3ft, 4ft, 5ft, 8ft and 10ft frame widths. Each EZ Tube® Connect frame easily connects, using aluminum tubing with push button snaps to lock and to attach to feet. Feet have two mounting points to connect frames side-by-side. Customize single- or double-sided stretch fabric graphics that pulls over frames and zips closed underneath. Medium Hard Case included. (Medium Hardcase Graphic optional)

DISPLAY DIMENSIONS	240"W x 90"H x 18.75"D
GRAPHIC SIZE 4FT	49"W x 89.5"H
GRAPHIC SIZE CIRCLE	84.75" W x 84.75" H
GRAPHIC SIZE MHC	62.375"W x 32.25"H

## GRAPHIC MATERIAL

Stretch Fabric

## GRAPHIC FINISHING

Sewn on left, right and top with zipper on the bottom

## DISPLAY CONSTRUCTION

34mm Aluminum Tubing

## SHIPPING WEIGHTS & DIMENSIONS

Shipping Weight	74 lbs (frames, graphics, MHC) Case 1 57 lbs (frames, graphics, MHC) Case 2
Shipping Dimensions	22"W x 39"H x 17"D (each case)

## GRAPHIC TURN AROUND TIME

2 business days after proof approval (up to 2 kits)

AVAILABILITY	Pacific Fulfillment Center
--------------	----------------------------

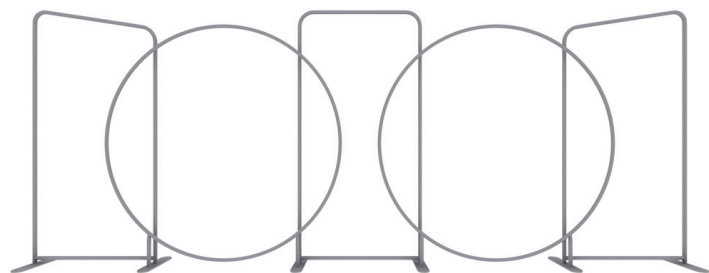

Single foot connection



Double foot connection

Foot Dims  
3 1/8" x 18 3/4"



Includes qty 2 Medium Hard Case  
 Case Inside Dimensions:  
 20.5"W x 32.5"H x 12"D



# EZ Tube® CONNECT 20FT KIT J (4'X7'X4X7'X4')

PRODUCT CATEGORY: EZ FABRIC DISPLAYS

PRODUCT CODE: EZCNCT-20KIT-J-4X7X4X7X4

## PARTS LIST

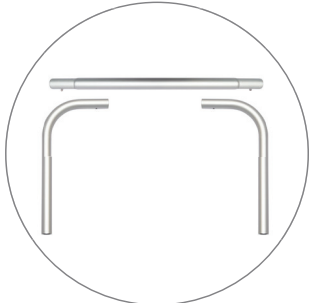

Top cross bar-4ft straight  
(qty 1)

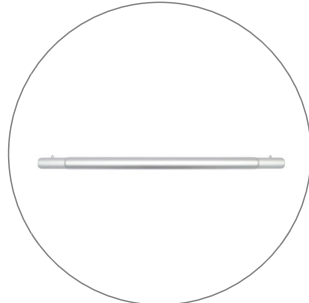

Bottom cross bar-4ft  
(qty 3)



3 section 64" pole  
(qty 6)



Bottom Cross Bar L shape  
connector  
(qty 6)



Top cross bar-4ft slope  
(qty 2)

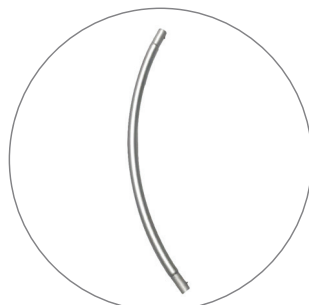

Male - Male Curved Tube  
(qty 4)



Male - Female Curved Tube  
(qty 10)



Bottom Tubes for Legs  
(qty 4)



Single Foot (34mm)  
(qty 2)



Double Foot (34mm)  
(qty 4)



Soft Bag 4ft  
(qty 3)



Soft Bag 7ft  
(qty 2)



MHC  
(qty 2)

# EZ Tube® CONNECT 2FT, 3FT, 4FT, & 5FT

PRODUCT CATEGORY: EZ FABRIC DISPLAYS

INSTRUCTIONS FOR 90" AND 96" FRAME HEIGHTS

## SETUP INSTRUCTIONS

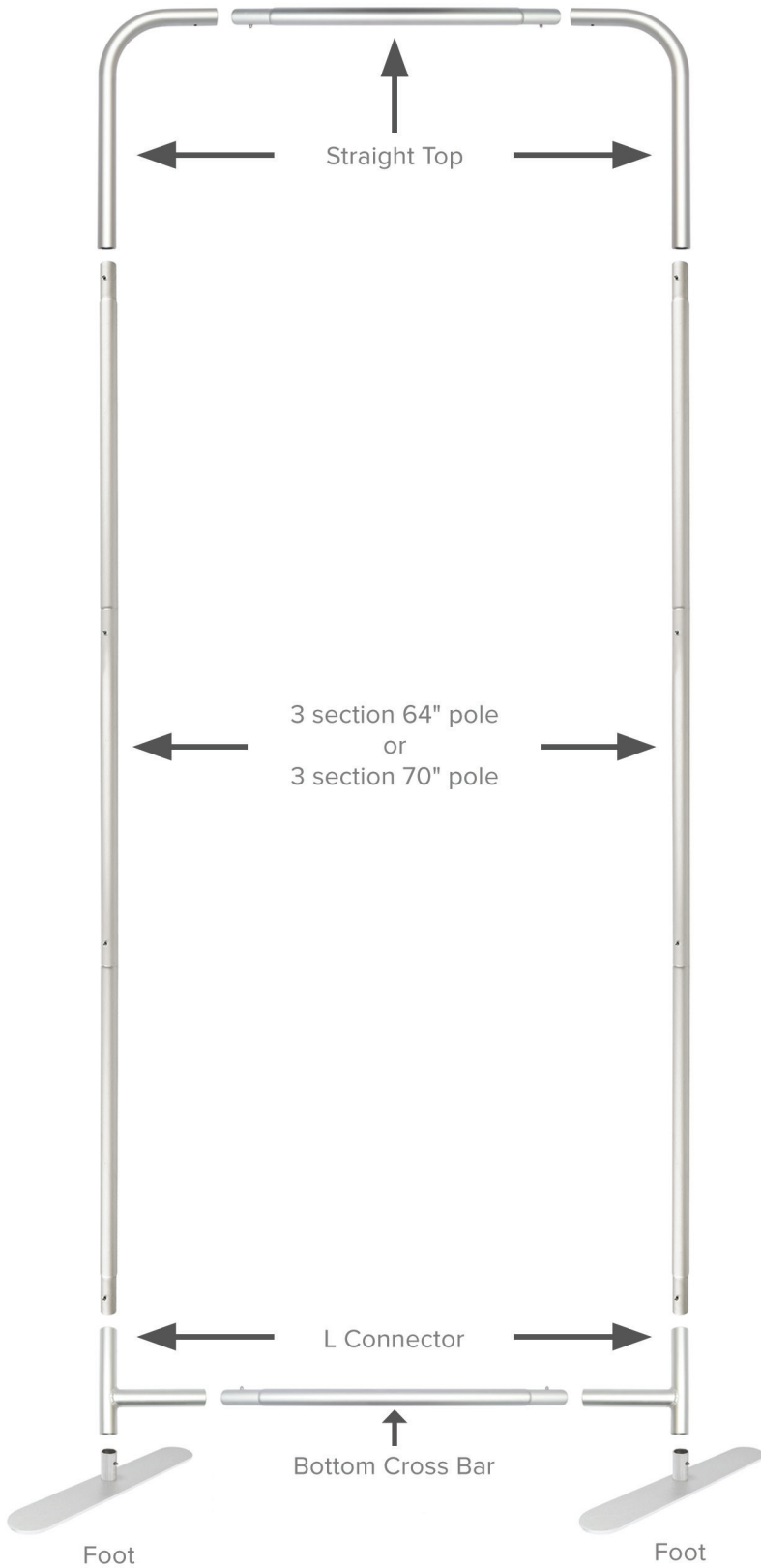

Optional top shapes for frame:



Curved Top



Slant Top

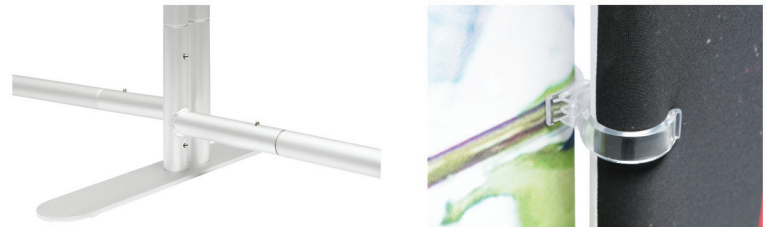

Use double foot and two connecting clips to connect frames side by side.

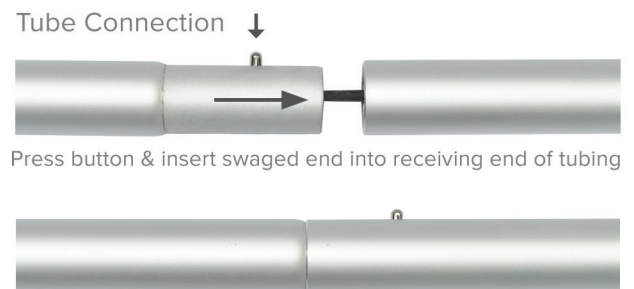

## SETUP INSTRUCTIONS

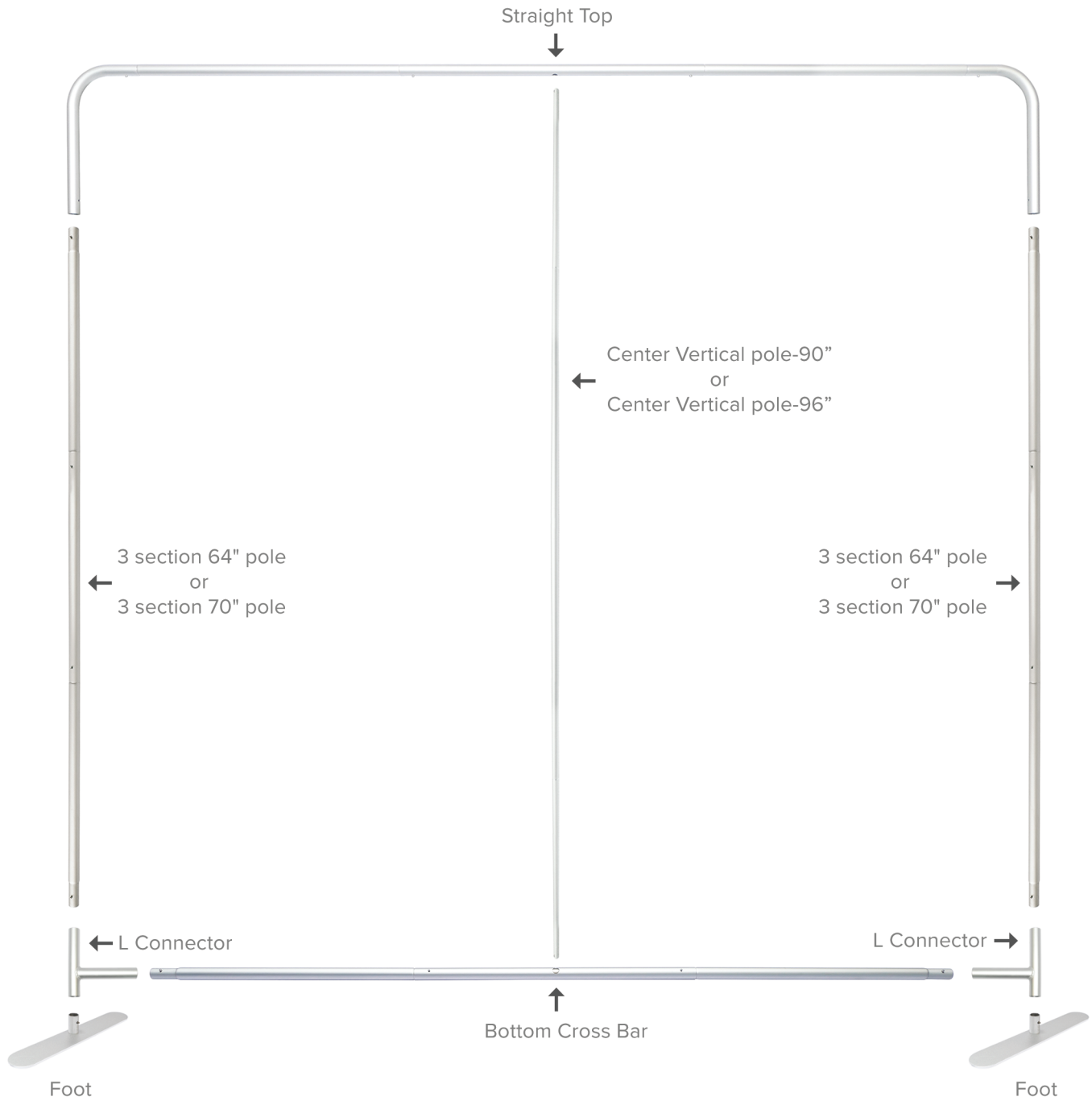

Use double foot and two connecting clips to connect frames side by side.



Tube Connection ↓

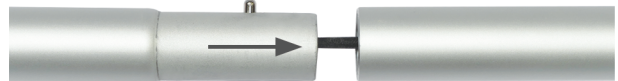

Press button & insert swaged end into receiving end of tubing



# EZ Tube® CONNECT CIRCLE 5FT

PRODUCT CATEGORY: EZ FABRIC DISPLAYS

PRODUCT CODE: EZCNCT-CIR5

## INSTRUCTIONS

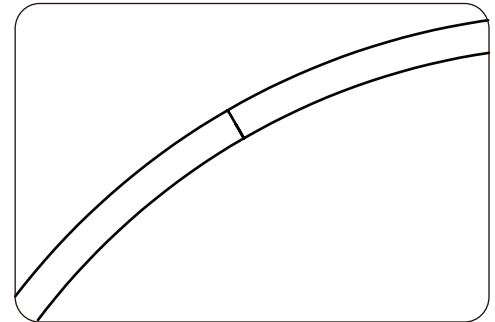
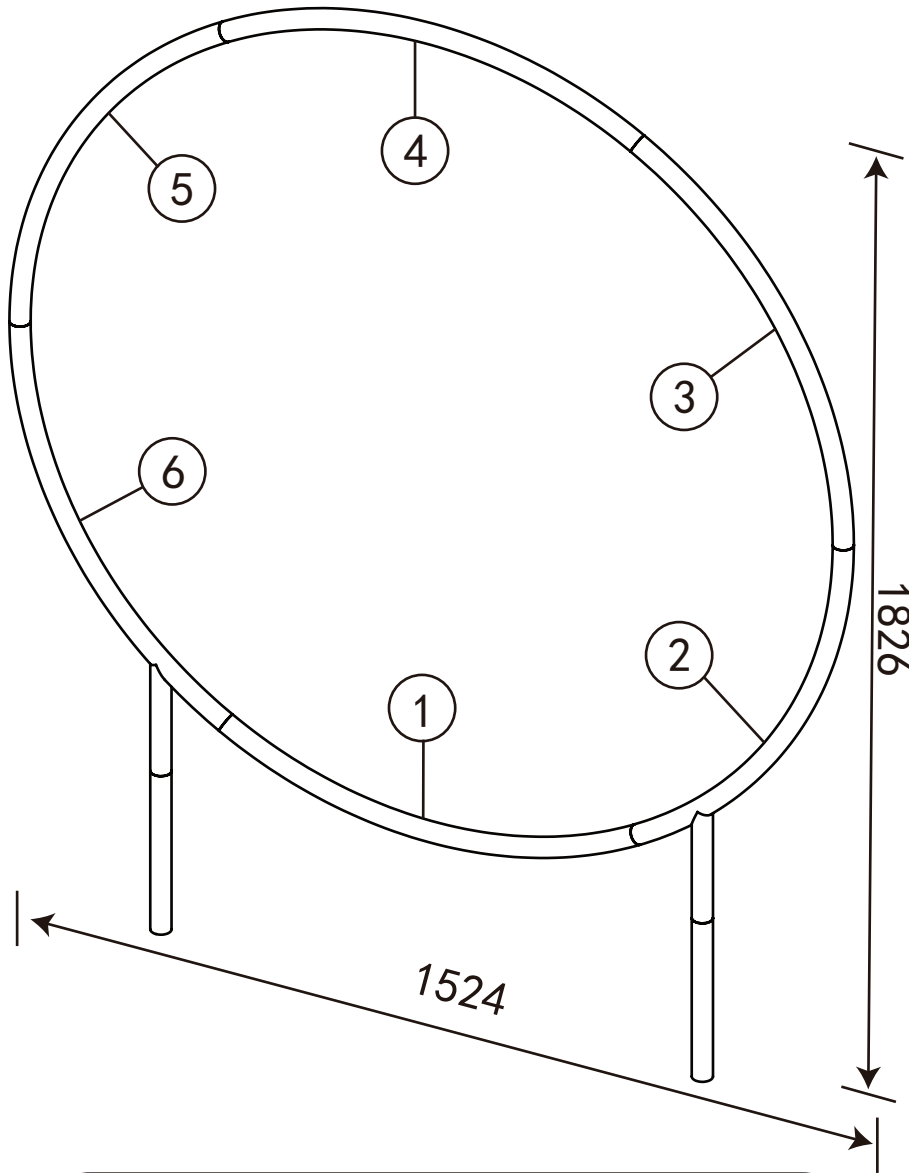

34-diameter tube, round stand,  
insert connection

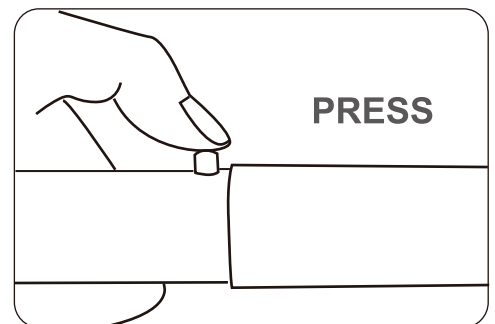
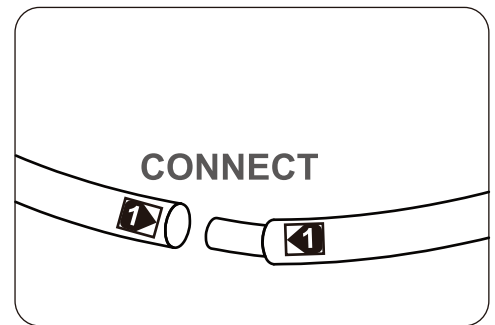

If can't snap when dismantle the frame, Pls push the tube forwardly, then push again.

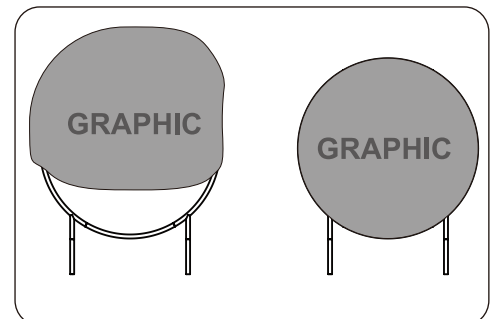
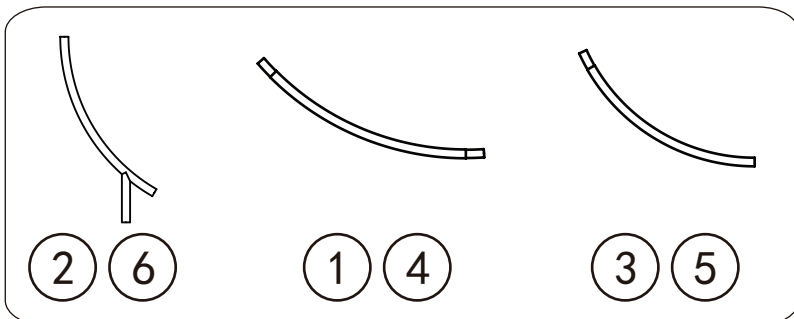

# EZ Tube® CONNECT CIRCLE 7FT

PRODUCT CATEGORY: EZ FABRIC DISPLAYS

PRODUCT CODE: EZCNCT-CIR7

## INSTRUCTIONS

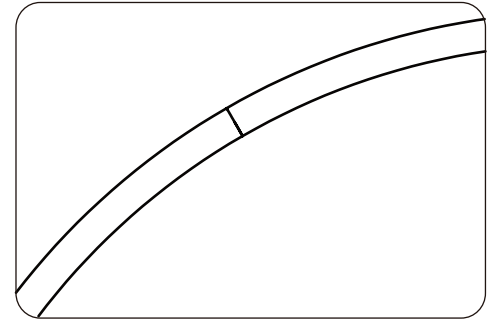
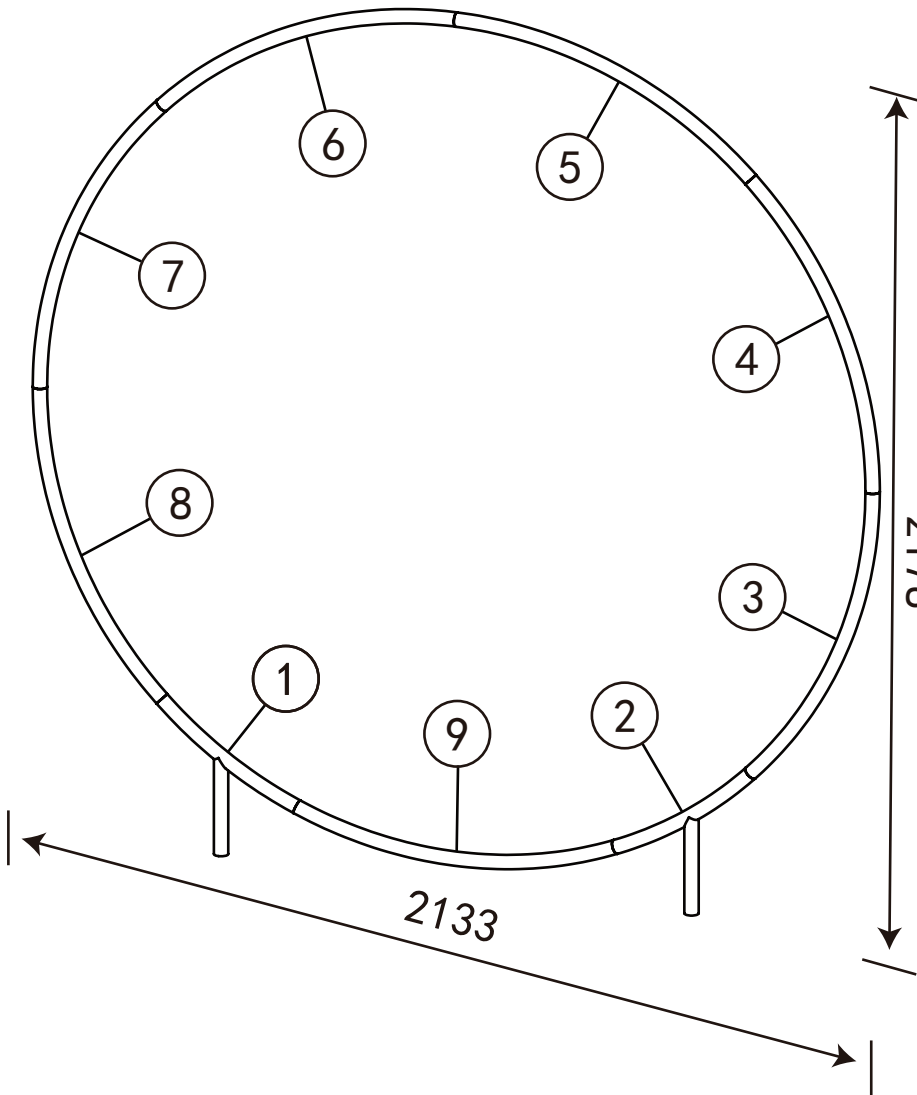

34-diameter tube, round stand,  
insert connection

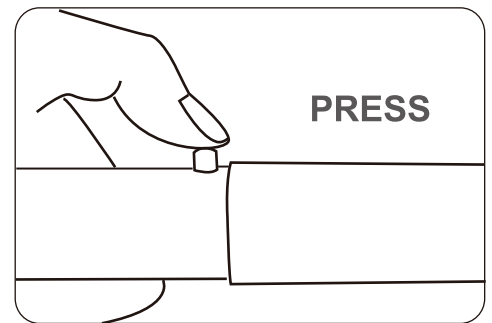
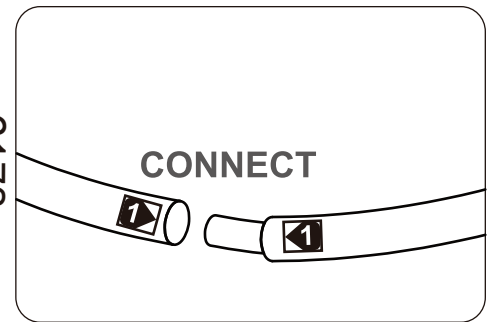

If can't snap when dismantle the frame, Pls push the  
tube forwardly, then push again.

