

EZ Tube® CONNECT 10FT Kit A (2'X5'X2')

PRODUCT CATEGORY: EZ FABRIC DISPLAYS

PRODUCT CODE: EZCNCT-10KIT-A-2X5X2



On frame On graphic



PRODUCT DESCRIPTION

Modular has officially met tube frames! EZ Tube® Connect modular tube display system lets you configure multiple shapes, sizes and frames. EZ Tube® Connect lets you choose from straight, round or slant top shapes, 90" or 96" frame heights, and 2ft, 3ft, 4ft, 5ft, 8ft and 10ft frame widths. Each EZ Tube® Connect frame easily connects, using aluminum tubing with push button snaps to lock and to attach to feet. Feet have two mounting points to connect frames side-by-side. Customizable single- or double-sided stretch fabric graphics that pulls over frames and zips closed underneath. Medium Hard Case included. (Medium Hardcase Graphic optional)

DISPLAY DIMENSIONS	120"W x 90"H x 18.75"D
GRAPHIC SIZE 2FT	25"W x 89.5"H
GRAPHIC SIZE 5FT	60.75" W x 89.5"H
GRAPHIC SIZE MHC	62.375"W x 32.25"H

GRAPHIC MATERIAL

Stretch Fabric

GRAPHIC FINISHING

Sewn on left, right and top with zipper on the bottom

DISPLAY CONSTRUCTION

34mm Aluminum Tubing

SHIPPING WEIGHTS & DIMENSIONS

Shipping Weight	60 lbs (frames and graphics)
Shipping Dimensions	22"W x 39"H x 17"D

LARGE QUANTITY FREIGHT

Freight Shipping	8 boxes per 48"L x 40"W x 43"H skid
Freight Weight	480 lbs (frames & graphics)

GRAPHIC TURN AROUND TIME

2 business days after proof approval (up to 2 kits)

AVAILABILITY	Pacific Fulfillment Center
--------------	----------------------------



Connecting Clip



Single foot connection



Double foot connection

Foot Dims
3 1/8" x 18 3/4"



Includes qty 1 Medium Hard Case
Case Inside Dimensions:
20.5"W x 32.5"H x 12"D

EZ Tube® CONNECT 10FT Kit A (2'X5'X2')

PRODUCT CATEGORY: EZ FABRIC DISPLAYS

PRODUCT CODE: EZCNCT-10KIT-A-2X5X2

PARTS LIST



Top cross bar-2ft slope
(qty 2)

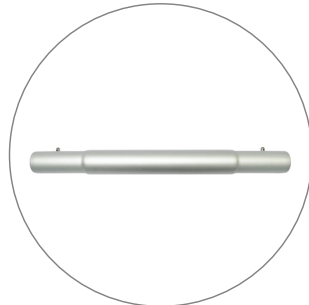

Bottom cross bar-2ft
(qty 2)



Top cross bar-5ft slope
(qty 1)

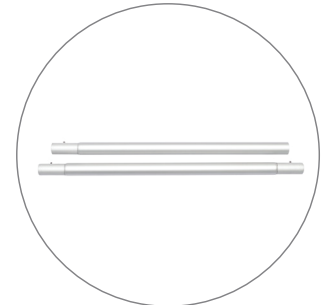

Bottom cross bar-5ft
(qty 1)

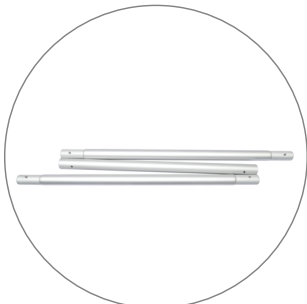

3 section 64" pole
(qty 6)

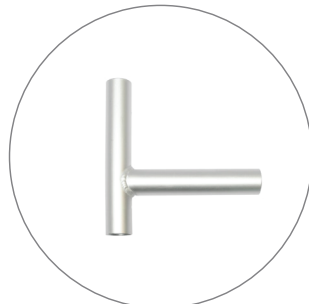

Bottom Cross Bar L
shape connector
(qty 6)



Single Foot (34mm)
(qty 2)



Double Foot (34mm)
(qty 2)



MHC
(qty 1)



Soft Bag 2ft
(qty 2)



Soft Bag 5ft
(qty 1)



Connecting Clip
(qty 4)

EZ Tube® CONNECT 10FT KIT B (3'X4'X3')

PRODUCT CATEGORY: EZ FABRIC DISPLAYS

PRODUCT CODE: EZCNCT-10KIT-B-3X4X3



On frame On graphic



PRODUCT DESCRIPTION

Modular has officially met tube frames! EZ Tube® Connect modular tube display system lets you configure multiple shapes, sizes and frames. EZ Tube® Connect lets you choose from straight, round or slant top shapes, 90" or 96" frame heights, and 2ft, 3ft, 4ft, 5ft, 8ft and 10ft frame widths. Each EZ Tube® Connect frame easily connects, using aluminum tubing with push button snaps to lock and to attach to feet. Feet have two mounting points to connect frames side-by-side. Customize single- or double-sided stretch fabric graphics that pulls over frames and zips closed underneath. Medium Hard Case included. (Medium Hardcase Graphic optional)

DISPLAY DIMENSIONS	120"W x 90"H x 18.75"D
GRAPHIC SIZE 3FT	37"W x 89.5"H
GRAPHIC SIZE 4FT	49"W x 89.5"H
GRAPHIC SIZE MHC	62.375"W x 32.25"H

GRAPHIC MATERIAL

Stretch Fabric

GRAPHIC FINISHING

Sewn on left, right and top with zipper on the bottom

DISPLAY CONSTRUCTION

34mm Aluminum Tubing

SHIPPING WEIGHTS & DIMENSIONS

Shipping Weight	62 lbs (frames and graphics)
Shipping Dimensions	22"W x 39"H x 17"D

LARGE QUANTITY FREIGHT

Freight Shipping	8 boxes per 48"L x 40"W x 43"H skid
Freight Weight	512 lbs (frames & graphics)

GRAPHIC TURN AROUND TIME

2 business days after proof approval (up to 2 kits)

AVAILABILITY	Pacific Fulfillment Center
--------------	----------------------------

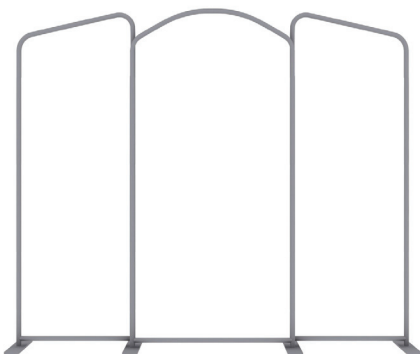

Connecting Clip



Single foot connection



Double foot connection

Foot Dims
3 1/8" x 18 3/4"



Includes qty 1 Medium Hard Case
Case Inside Dimensions:
20.5"W x 32.5"H x 12"D

EZ Tube® CONNECT 10FT KIT B (3'X4'X3')

PRODUCT CATEGORY: EZ FABRIC DISPLAYS

PRODUCT CODE: EZCNCT-10KIT-B-3X4X3

PARTS LIST

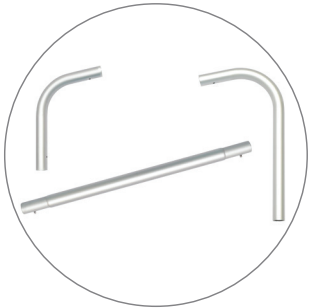

Top cross bar-3ft slope
(qty 2)

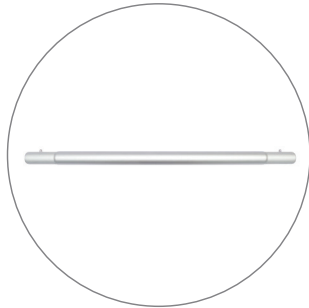

Bottom cross bar-3ft
(qty 2)



Top cross bar-4ft round
(qty 1)

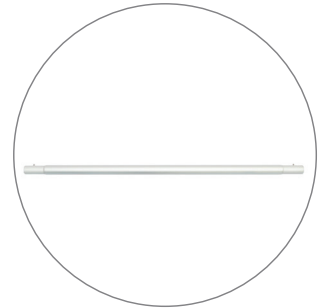

Bottom cross bar-4ft
(qty 1)

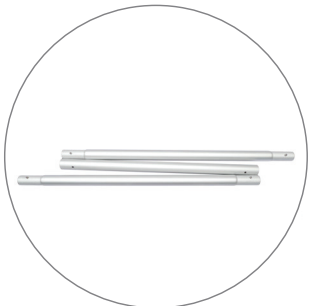

3 section 64" pole
(qty 4)

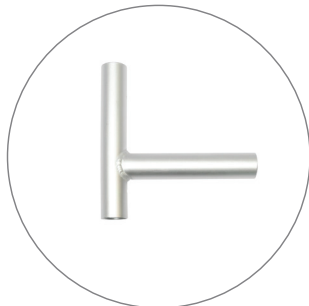

Bottom Cross Bar L
shape connector
(qty 6)



Single Foot (34mm)
(qty 2)

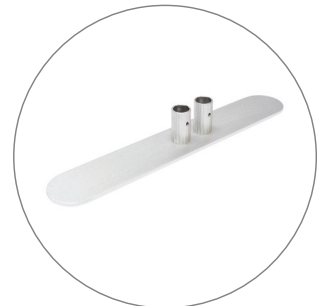

Double Foot (34mm)
(qty 2)



MHC
(qty 1)



Soft Bag 3ft
(qty 2)



Soft Bag 4ft
(qty 1)



Connecting Clip
(qty 4)

EZ Tube® CONNECT 10FT KIT C (4'X2'X4')

PRODUCT CATEGORY: EZ FABRIC DISPLAYS

PRODUCT CODE: EZCNCT-10KIT-C-4X2X4



On frame On graphic



Single foot connection



Double foot connection

Foot Dims
3 1/8" x 18 3/4"

PRODUCT DESCRIPTION

Modular has officially met tube frames! EZ Tube® Connect modular tube display system lets you configure multiple shapes, sizes and frames. EZ Tube® Connect lets you choose from straight, round or slant top shapes, 90" or 96" frame heights, and 2ft, 3ft, 4ft, 5ft, 8ft and 10ft frame widths. Each EZ Tube® Connect frame easily connects, using aluminum tubing with push button snaps to lock and to attach to feet. Feet have two mounting points to connect frames side-by-side. Customize single- or double-sided stretch fabric graphics that pulls over frames and zips closed underneath. Medium Hard Case included. (Medium Hardcase Graphic optional)

DISPLAY DIMENSIONS	120"W x 90"H x 18.75"D
GRAPHIC SIZE 2FT	25"W x 89.5"H
GRAPHIC SIZE 4FT	49"W x 89.5"H
GRAPHIC SIZE MHC	62.375"W x 32.25"H

GRAPHIC MATERIAL

Stretch Fabric

GRAPHIC FINISHING

Sewn on left, right and top with zipper on the bottom

DISPLAY CONSTRUCTION

34mm Aluminum Tubing

SHIPPING WEIGHTS & DIMENSIONS

Shipping Weight	61 lbs (frames and graphics)
Shipping Dimensions	22"W x 39"H x 17"D

LARGE QUANTITY FREIGHT

Freight Shipping	8 boxes per 48"L x 40"W x 43"H skid
Freight Weight	488 lbs (frames & graphics - 4 sets)

GRAPHIC TURN AROUND TIME

2 business days after proof approval (up to 2 kits)

AVAILABILITY	Pacific Fulfillment Center
--------------	----------------------------



Connecting Clip



Includes qty 1 Medium Hard Case
Case Inside Dimensions:
20.5"W x 32.5"H x 12"D

EZ Tube® CONNECT 10FT KIT C (4'X2'X4')

PRODUCT CATEGORY: EZ FABRIC DISPLAYS

PRODUCT CODE: EZCNCT-10KIT-C-4X2X4

PARTS LIST

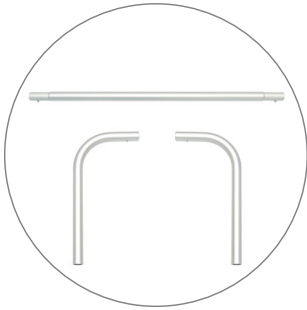

Top cross bar-4ft straight
(qty 2)

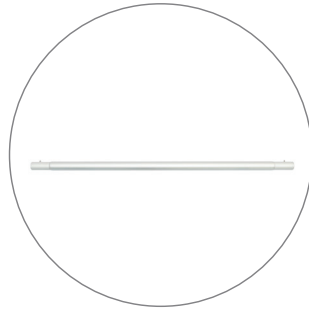

Bottom cross bar-4ft
(qty 2)



Top cross bar-2ft round
(qty 1)

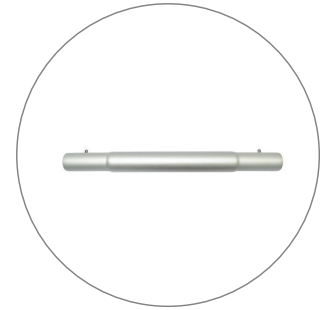

Bottom cross bar-2ft
(qty 1)



3 section 64" pole
(qty 6)

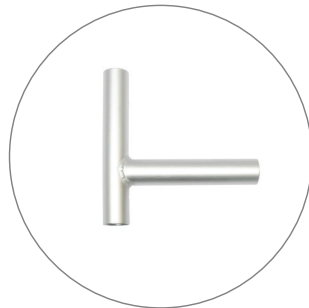

Bottom Cross Bar L
shape connector
(qty 6)



Single Foot (34mm)
(qty 2)



Double Foot (34mm)
(qty 2)



MHC
(qty 1)



Soft Bag 4ft
(qty 2)



Soft Bag 2ft
(qty 1)



Connecting Clip
(qty 4)

EZ Tube® CONNECT 10FT KIT D (5'X5')

PRODUCT CATEGORY: EZ FABRIC DISPLAYS

PRODUCT CODE: EZCNCT-10KIT-D-5X5



On frame On graphic



PRODUCT DESCRIPTION

Modular has officially met tube frames! EZ Tube® Connect modular tube display system lets you configure multiple shapes, sizes and frames. EZ Tube® Connect lets you choose from straight, round or slant top shapes, 90" or 96" frame heights, and 2ft, 3ft, 4ft, 5ft, 8ft and 10ft frame widths. Each EZ Tube® Connect frame easily connects, using aluminum tubing with push button snaps to lock and to attach to feet. Feet have two mounting points to connect frames side-by-side. Customize single- or double-sided stretch fabric graphics that pulls over frames and zips closed underneath. Medium Hard Case included. (Medium Hardcase Graphic optional)

DISPLAY DIMENSIONS	120"W x 90"H x 18.75"D
GRAPHIC SIZE 5FT	60.75"W x 89.5"H
GRAPHIC SIZE MHC	62.375"W x 32.25"H

GRAPHIC MATERIAL

Stretch Fabric

GRAPHIC FINISHING

Sewn on left, right and top with zipper on the bottom

DISPLAY CONSTRUCTION

34mm Aluminum Tubing

SHIPPING WEIGHTS & DIMENSIONS

Shipping Weight	53 lbs (frames and graphics)
Shipping Dimensions	22"W x 39"H x 17"D

LARGE QUANTITY FREIGHT

Freight Shipping	8 boxes per 48"L x 40"W x 43"H skid
Freight Weight	424 lbs (frames & graphics)

GRAPHIC TURN AROUND TIME

2 business days after proof approval (up to 2 kits)

AVAILABILITY	Pacific Fulfillment Center
--------------	----------------------------

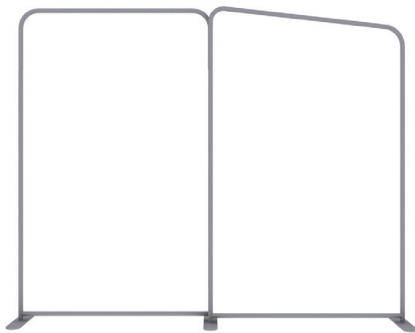

Connecting Clip



Single foot connection



Double foot connection

Foot Dims
3 1/8" x 18 3/4"



Includes qty 1 Medium Hard Case
Case Inside Dimensions:
20.5"W x 32.5"H x 12"D

EZ Tube® CONNECT 10FT KIT D (5'X5')

PRODUCT CATEGORY: EZ FABRIC DISPLAYS

PRODUCT CODE: EZCNCT-10KIT-D-5X5

PARTS LIST

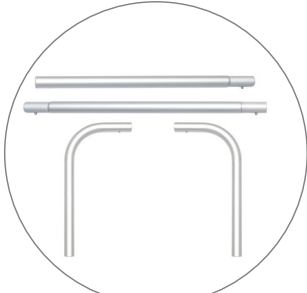

Top cross bar-5ft straight
(qty 1)

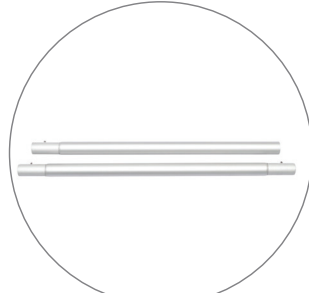

Bottom cross bar-5ft
(qty 2)



Top cross bar-5ft slope
(qty 1)



3 section 64" pole
(qty 4)

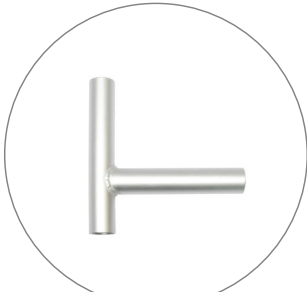

Bottom Cross Bar L shape
connector
(qty 4)



Single Foot (34mm)
(qty 2)



Double Foot (34mm)
(qty 1)



MHC
(qty 1)



Soft Bag 5ft
(qty 2)



Connecting Clip
(qty 4)

EZ Tube® CONNECT 10FT KIT E (3'X4'X3')

PRODUCT CATEGORY: EZ FABRIC DISPLAYS

PRODUCT CODE: EZCNCT-10KIT-E-3X4X3



On frame On graphic

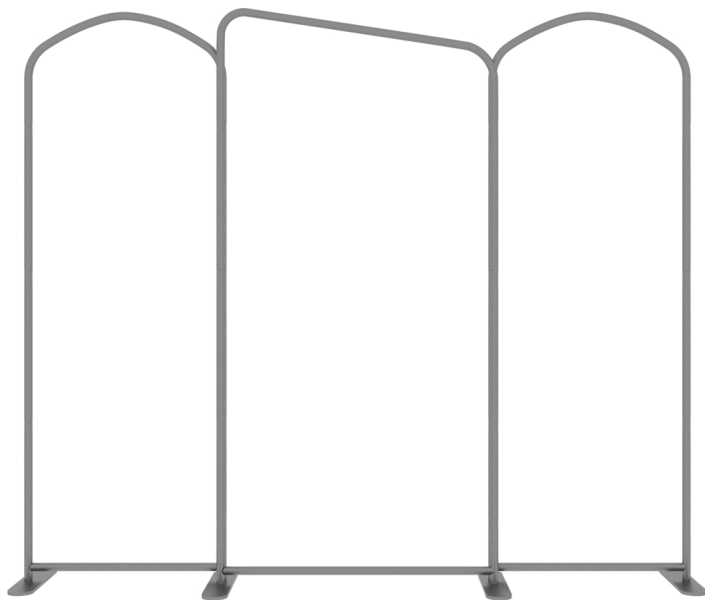

Single foot connection



Double foot connection

Foot Dims
3 1/8" x 18 3/4"

PRODUCT DESCRIPTION

Modular has officially met tube frames! EZ Tube® Connect modular tube display system lets you configure multiple shapes, sizes and frames. EZ Tube® Connect lets you choose from straight, round or slant top shapes, 90" or 96" frame heights, and 2ft, 3ft, 4ft, 5ft, 8ft and 10ft frame widths. Each EZ Tube® Connect frame easily connects, using aluminum tubing with push button snaps to lock and to attach to feet. Feet have two mounting points to connect frames side-by-side. Customize single- or double-sided stretch fabric graphics that pulls over frames and zips closed underneath. Medium Hard Case included. (Medium Hardcase Graphic optional)

DISPLAY DIMENSIONS	120"W x 90"H x 18.75"D
GRAPHIC SIZE 3FT	37"W x 89.5"H
GRAPHIC SIZE 4FT	49"W x 89.5"H
GRAPHIC SIZE MHC	62.375"W x 32.25"H

GRAPHIC MATERIAL

Stretch Fabric

GRAPHIC FINISHING

Sewn on left, right and top with zipper on the bottom

DISPLAY CONSTRUCTION

34mm Aluminum Tubing

SHIPPING WEIGHTS & DIMENSIONS

Shipping Weight	62 lbs (frames and graphics)
Shipping Dimensions	22"W x 39"H x 17"D

LARGE QUANTITY FREIGHT

Freight Shipping	8 boxes per 48"L x 40"W x 43"H skid
Freight Weight	512 lbs (frames & graphics)

GRAPHIC TURN AROUND TIME

2 business days after proof approval (up to 2 kits)

AVAILABILITY	Pacific Fulfillment Center
--------------	----------------------------



Connecting Clip



Includes qty 1 Medium Hard Case
Case Inside Dimensions:
20.5"W x 32.5"H x 12"D

EZ Tube® CONNECT 10FT KIT E (3'X4'X3')

PRODUCT CATEGORY: EZ FABRIC DISPLAYS

PRODUCT CODE: EZCNCT-10KIT-E-3X4X3

PARTS LIST



Top cross bar-3ft round
(qty 2)

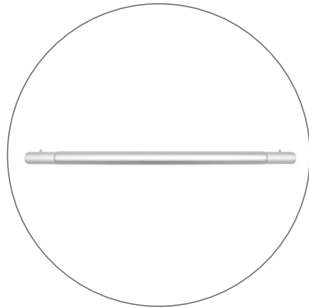

Bottom cross bar-3ft
(qty 2)

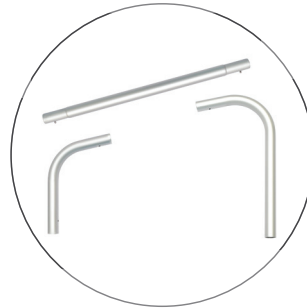

Top cross bar-4ft slope
(qty 1)

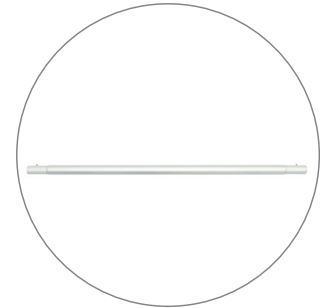

Bottom cross bar-4ft
(qty 1)

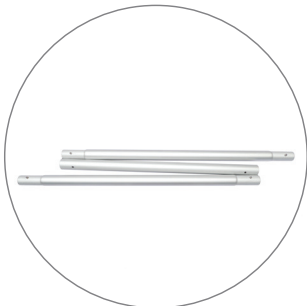

3 section 64" pole
(qty 6)



Bottom Cross Bar L
shape connector
(qty 6)



Single Foot (34mm)
(qty 2)



Double Foot (34mm)
(qty 2)



MHC
(qty 1)



Soft Bag 3ft
(qty 2)



Soft Bag 4ft
(qty 1)



Connecting Clip
(qty 4)

EZ Tube® CONNECT 10FT KIT F (3'X3'X3')

PRODUCT CATEGORY: EZ FABRIC DISPLAYS

PRODUCT CODE: EZCNCT-10KIT-F-3X3X3



On frame On graphic

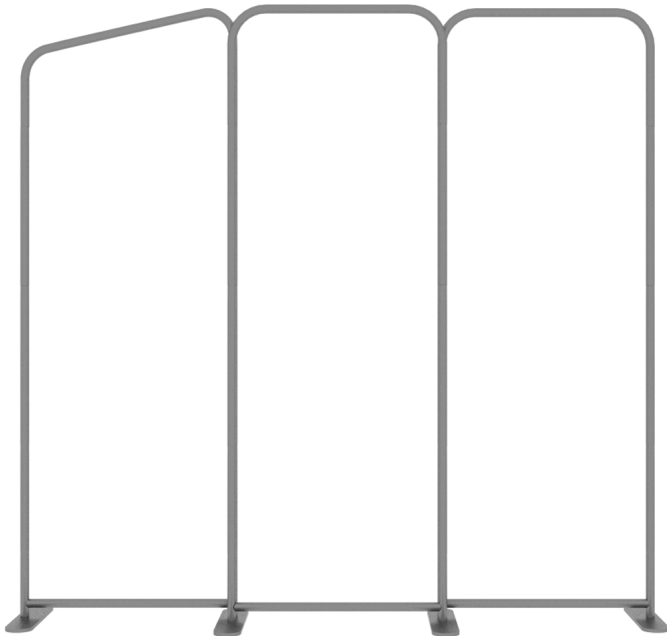

PRODUCT DESCRIPTION

Modular has officially met tube frames! EZ Tube® Connect modular tube display system lets you configure multiple shapes, sizes and frames. EZ Tube® Connect lets you choose from straight, round or slant top shapes, 90" or 96" frame heights, and 2ft, 3ft, 4ft, 5ft, 8ft and 10ft frame widths. Each EZ Tube® Connect frame easily connects, using aluminum tubing with push button snaps to lock and to attach to feet. Feet have two mounting points to connect frames side-by-side. Customize single- or double-sided stretch fabric graphics that pulls over frames and zips closed underneath. Medium Hard Case included. (Medium Hardcase Graphic optional)

DISPLAY DIMENSIONS	120"W x 90"H x 18.75"D
GRAPHIC SIZE 3FT	37"W x 89.5"H
GRAPHIC SIZE MHC	62.375"W x 32.25"H

GRAPHIC MATERIAL

Stretch Fabric

GRAPHIC FINISHING

Sewn on left, right and top with zipper on the bottom

DISPLAY CONSTRUCTION

34mm Aluminum Tubing

SHIPPING WEIGHTS & DIMENSIONS

Shipping Weight	86 lbs (frames and graphics)
Shipping Dimensions	22"W x 39"H x 17"D

LARGE QUANTITY FREIGHT

Freight Shipping	8 boxes per 48"L x 40"W x 43"H skid
Freight Weight	512 lbs (frames & graphics)

GRAPHIC TURN AROUND TIME

2 business days after proof approval (up to 2 kits)

AVAILABILITY	Pacific Fulfillment Center
--------------	----------------------------



Connecting Clip



Single foot connection



Double foot connection

Foot Dims
3 1/8" x 18 3/4"



Includes qty 1 Medium Hard Case
Case Inside Dimensions:
20.5"W x 32.5"H x 12"D

EZ Tube® CONNECT 10FT KIT F (3'X3'X3')

PRODUCT CATEGORY: EZ FABRIC DISPLAYS

PRODUCT CODE: EZCNCT-10KIT-F-3X3X3

PARTS LIST

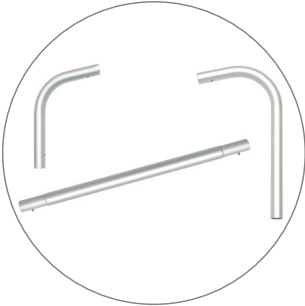

Top cross bar-3ft slope
(qty 1)

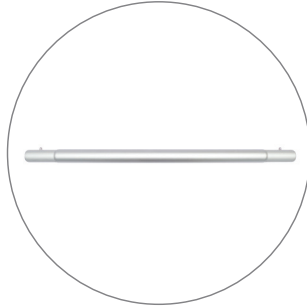

Bottom cross bar-3ft
(qty 3)

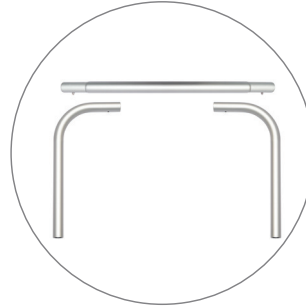

Top cross bar-3ft straight
(qty 2)



Connecting Clip
(qty 4)

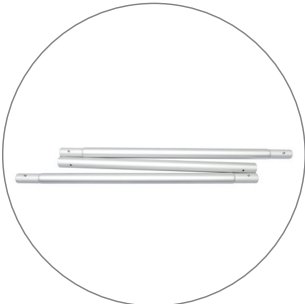

3 section 64" pole
(qty 6)

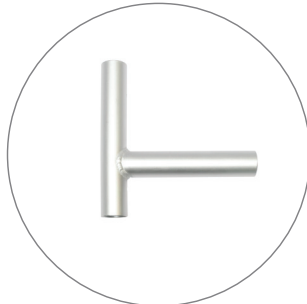

Bottom Cross Bar L
shape connector
(qty 6)



Single Foot (34mm)
(qty 2)



Double Foot (34mm)
(qty 2)



MHC
(qty 1)



Soft Bag 3ft
(qty 3)

EZ Tube® CONNECT 10FT KIT G (4'X2'X4')

PRODUCT CATEGORY: EZ FABRIC DISPLAYS

PRODUCT CODE: EZNCT-10KIT-G-4X2X4



On frame On graphic

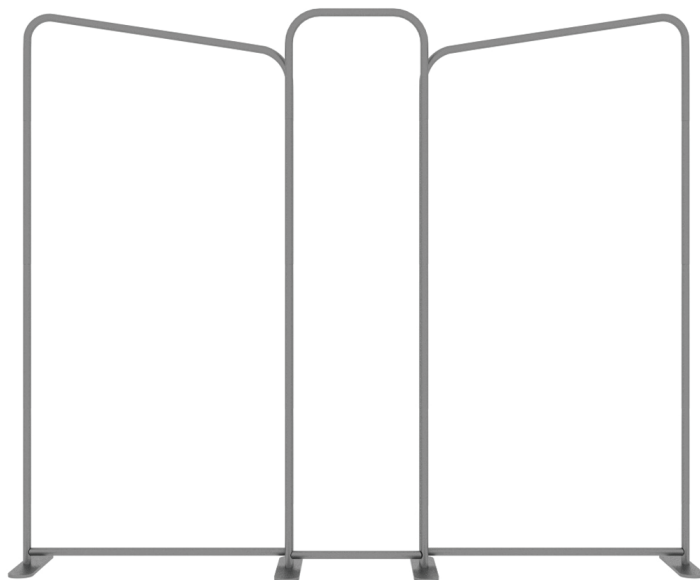

Single foot connection



Double foot connection

Foot Dims
3 1/8" x 18 3/4"

PRODUCT DESCRIPTION

Modular has officially met tube frames! EZ Tube® Connect modular tube display system lets you configure multiple shapes, sizes and frames. EZ Tube® Connect lets you choose from straight, round or slant top shapes, 90" or 96" frame heights, and 2ft, 3ft, 4ft, 5ft, 8ft and 10ft frame widths. Each EZ Tube® Connect frame easily connects, using aluminum tubing with push button snaps to lock and to attach to feet. Feet have two mounting points to connect frames side-by-side. Customize single- or double-sided stretch fabric graphics that pulls over frames and zips closed underneath. Medium Hard Case included. (Medium Hardcase Graphic optional)

DISPLAY DIMENSIONS	120"W x 90"H x 18.75"D
GRAPHIC SIZE 2FT	25"W x 89.5"H
GRAPHIC SIZE 4FT	49"W x 89.5"H
GRAPHIC SIZE MHC	62.375"W x 32.25"H

GRAPHIC MATERIAL

Stretch Fabric

GRAPHIC FINISHING

Sewn on left, right and top with zipper on the bottom

DISPLAY CONSTRUCTION

34mm Aluminum Tubing

SHIPPING WEIGHTS & DIMENSIONS

Shipping Weight	61 lbs (frames and graphics)
Shipping Dimensions	22"W x 39"H x 17"D

LARGE QUANTITY FREIGHT

Freight Shipping	8 boxes per 48"L x 40"W x 43"H skid
Freight Weight	488 lbs (frames & graphics - 4 sets)

GRAPHIC TURN AROUND TIME

2 business days after proof approval (up to 2 kits)

AVAILABILITY	Pacific Fulfillment Center
--------------	----------------------------



Connecting Clip



Includes qty 1 Medium Hard Case
Case Inside Dimensions:
20.5"W x 32.5"H x 12"D

EZ Tube® CONNECT 10FT KIT G (4'X2'X4')

PRODUCT CATEGORY: EZ FABRIC DISPLAYS

PRODUCT CODE: EZCNCT-10KIT-G-4X2X4

PARTS LIST



Top cross bar-4ft slope
(qty 2)

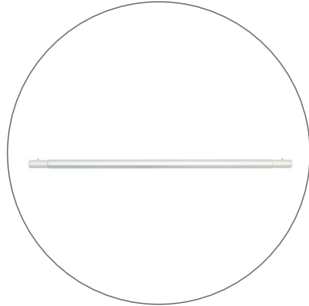

Bottom cross bar-4ft
(qty 2)

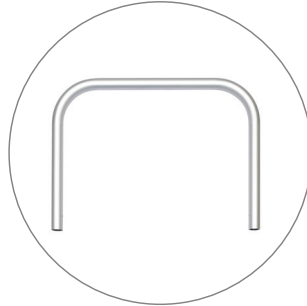

Top cross bar-2ft straight
(qty 1)



Bottom cross bar-2ft
(qty 1)



3 section 64" pole
(qty 6)



Bottom Cross Bar L
shape connector
(qty 6)



Single Foot (34mm)
(qty 2)



Double Foot (34mm)
(qty 2)



MHC
(qty 1)



Soft Bag 4ft
(qty 2)



Soft Bag 2ft
(qty 1)



Connecting Clip
(qty 4)

EZ Tube® CONNECT 10FT KIT H (5'X5')

PRODUCT CATEGORY: EZ FABRIC DISPLAYS

PRODUCT CODE: EZNCT-10KIT-H-5X5



On frame On graphic

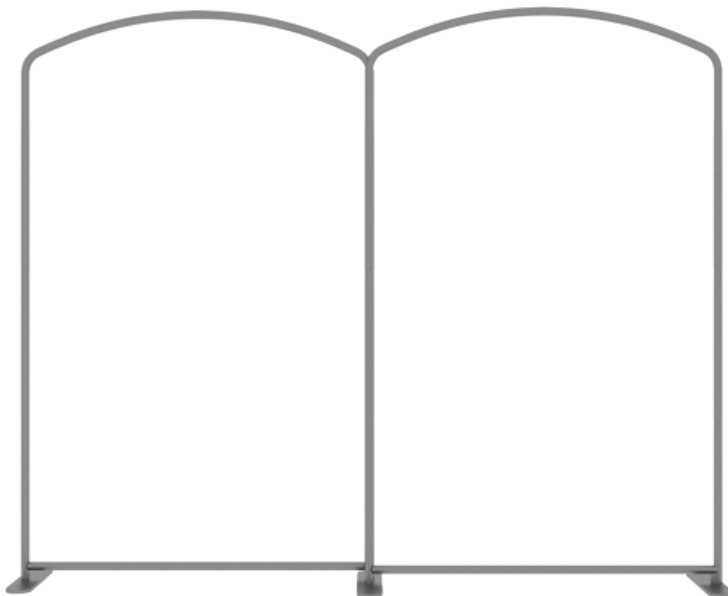

Single foot connection



Double foot connection

Foot Dims
3 1/8" x 18 3/4"

PRODUCT DESCRIPTION

Modular has officially met tube frames! EZ Tube® Connect modular tube display system lets you configure multiple shapes, sizes and frames. EZ Tube® Connect lets you choose from straight, round or slant top shapes, 90" or 96" frame heights, and 2ft, 3ft, 4ft, 5ft, 8ft and 10ft frame widths. Each EZ Tube® Connect frame easily connects, using aluminum tubing with push button snaps to lock and to attach to feet. Feet have two mounting points to connect frames side-by-side. Customize single- or double-sided stretch fabric graphics that pulls over frames and zips closed underneath. Medium Hard Case included. (Medium Hardcase Graphic optional)

DISPLAY DIMENSIONS	120"W x 90"H x 18.75"D
GRAPHIC SIZE 5FT	60.75"W x 89.5"H
GRAPHIC SIZE MHC	62.375"W x 32.25"H

GRAPHIC MATERIAL

Stretch Fabric

GRAPHIC FINISHING

Sewn on left, right and top with zipper on the bottom

DISPLAY CONSTRUCTION

34mm Aluminum Tubing

SHIPPING WEIGHTS & DIMENSIONS

Shipping Weight	53 lbs (frames and graphics)
Shipping Dimensions	22"W x 39"H x 17"D

LARGE QUANTITY FREIGHT

Freight Shipping	8 boxes per 48"L x 40"W x 43"H skid
Freight Weight	424 lbs (frames & graphics)

GRAPHIC TURN AROUND TIME

2 business days after proof approval (up to 2 kits)

AVAILABILITY	Pacific Fulfillment Center
--------------	----------------------------



Connecting Clip



Includes qty 1 Medium Hard Case
Case Inside Dimensions:
20.5"W x 32.5"H x 12"D

EZ Tube® CONNECT 10FT KIT H (5'X5')

PRODUCT CATEGORY: EZ FABRIC DISPLAYS

PRODUCT CODE: EZCNCT-10KIT-H-5X5

PARTS LIST



Top cross bar-5ft round
(qty 2)

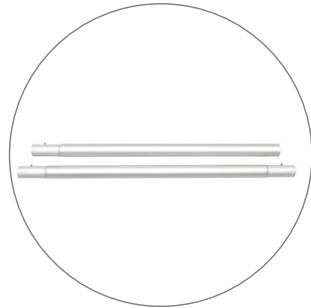

Bottom cross bar-5ft
(qty 2)



3 section 64" pole
(qty 4)



Connecting Clip
(qty 4)

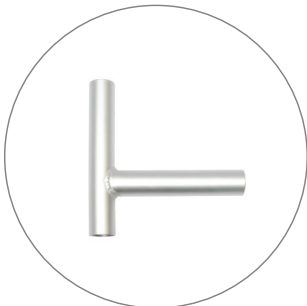

Bottom Cross Bar L shape
connector
(qty 4)



Single Foot (34mm)
(qty 2)



Double Foot (34mm)
(qty 1)



MHC
(qty 1)



Soft Bag 5ft
(qty 2)

EZ Tube® CONNECT 10FT KIT I (3'X3'X3')

PRODUCT CATEGORY: EZ FABRIC DISPLAYS

PRODUCT CODE: EZCNCT-10KIT-I-3X3X3



On frame On graphic

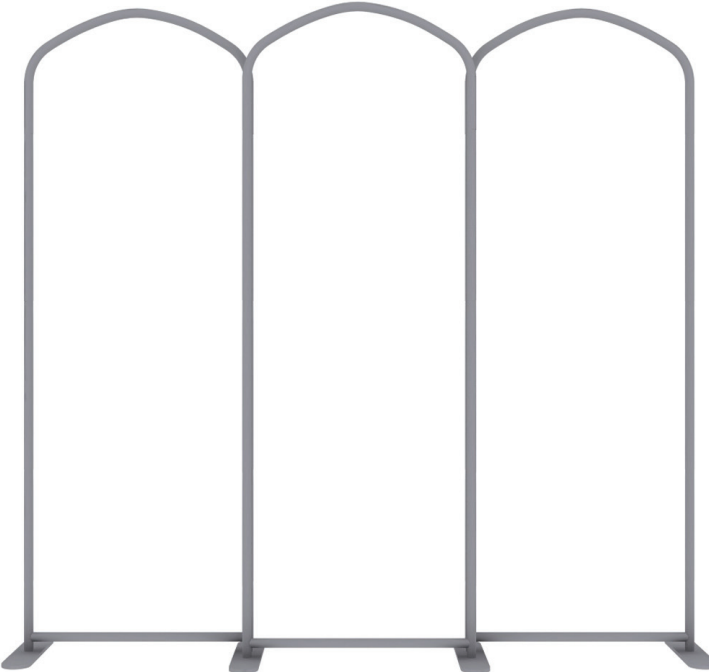

Single foot connection



Double foot connection

Foot Dims
3 1/8" x 18 3/4"

PRODUCT DESCRIPTION

Modular has officially met tube frames! EZ Tube® Connect modular tube display system lets you configure multiple shapes, sizes and frames. EZ Tube® Connect lets you choose from straight, round or slant top shapes, 90" or 96" frame heights, and 2ft, 3ft, 4ft, 5ft, 8ft and 10ft frame widths. Each EZ Tube® Connect frame easily connects, using aluminum tubing with push button snaps to lock and to attach to feet. Feet have two mounting points to connect frames side-by-side. Customize single- or double-sided stretch fabric graphics that pulls over frames and zips closed underneath. Medium Hard Case included. (Medium Hardcase Graphic optional)

DISPLAY DIMENSIONS	120"W x 90"H x 18.75"D
GRAPHIC SIZE 3FT	37"W x 89.5"H
GRAPHIC SIZE MHC	62.375"W x 32.25"H

GRAPHIC MATERIAL

Stretch Fabric

GRAPHIC FINISHING

Sewn on left, right and top with zipper on the bottom

DISPLAY CONSTRUCTION

34mm Aluminum Tubing

SHIPPING WEIGHTS & DIMENSIONS

Shipping Weight	86 lbs (frames and graphics)
Shipping Dimensions	22"W x 39"H x 17"D

LARGE QUANTITY FREIGHT

Freight Shipping	8 boxes per 48"L x 40"W x 43"H skid
Freight Weight	512 lbs (frames & graphics)

GRAPHIC TURN AROUND TIME

2 business days after proof approval (up to 2 kits)

AVAILABILITY	Pacific Fulfillment Center
--------------	----------------------------



Connecting Clip



Includes qty 1 Medium Hard Case
Case Inside Dimensions:
20.5"W x 32.5"H x 12"D

EZ Tube® CONNECT 10FT KIT I (3'X3'X3')

PRODUCT CATEGORY: EZ FABRIC DISPLAYS

PRODUCT CODE: EZCNCT-10KIT-I-3X3X3

PARTS LIST



Top cross bar-3ft round
(qty 3)

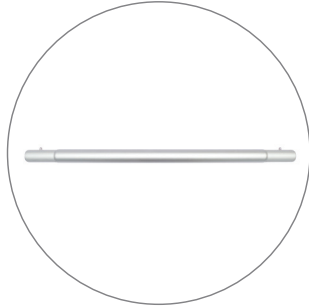

Bottom cross bar-3ft
(qty 3)



Connecting Clip
(qty 4)



3 section 64" pole
(qty 6)

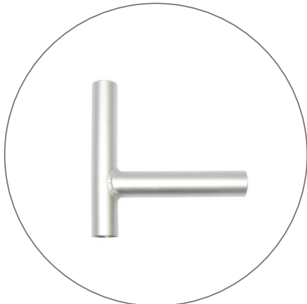

Bottom Cross Bar L shape
connector
(qty 6)



Single Foot (34mm)
(qty 2)



Double Foot (34mm)
(qty 2)



Soft Bag 3ft
(qty 3)



MHC
(qty 1)

EZ Tube® CONNECT 10FT KIT J (3'X5'X3')

PRODUCT CATEGORY: EZ FABRIC DISPLAYS

PRODUCT CODE: EZCNCT-10KIT-J-3X5X3



On frame On graphic

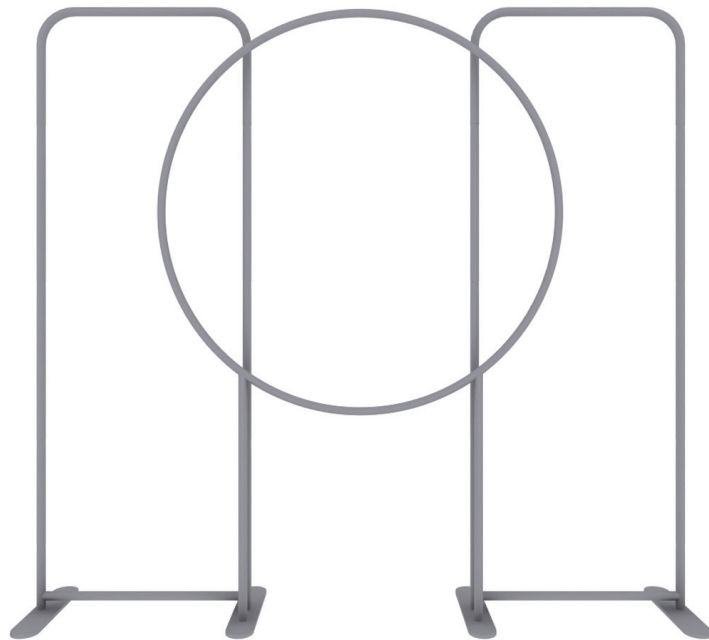

Single foot connection



Double foot connection

Foot Dims
3 1/8" x 18 3/4"

PRODUCT DESCRIPTION

Modular has officially met tube frames! EZ Tube® Connect modular tube display system lets you configure multiple shapes, sizes and frames. EZ Tube® Connect lets you choose from straight, round or slant top shapes, 90" or 96" frame heights, and 2ft, 3ft, 4ft, 5ft, 8ft and 10ft frame widths. Each EZ Tube® Connect frame easily connects, using aluminum tubing with push button snaps to lock and to attach to feet. Feet have two mounting points to connect frames side-by-side. Customize single- or double-sided stretch fabric graphics that pulls over frames and zips closed underneath. Medium Hard Case included. (Medium Hardcase Graphic optional)

DISPLAY DIMENSIONS	120"W x 90"H x 18.75"D
GRAPHIC SIZE 3FT	37"W x 89.5"H
GRAPHIC SIZE CIRCLE	61" W x 61" H
GRAPHIC SIZE MHC	62.375"W x 32.25"H

GRAPHIC MATERIAL

Stretch Fabric

GRAPHIC FINISHING

Sewn on left, right and top with zipper on the bottom

DISPLAY CONSTRUCTION

34mm Aluminum Tubing

SHIPPING WEIGHTS & DIMENSIONS

Shipping Weight	73 lbs (frames, graphics, & MHC)
Shipping Dimensions	22"W x 39"H x 17"D

LARGE QUANTITY FREIGHT

Freight Shipping	8 boxes per 48"L x 40"W x 43"H skid
Freight Weight	584 lbs (frames, graphics, & MHC)

GRAPHIC TURN AROUND TIME

2 business days after proof approval (up to 2 kits)

AVAILABILITY	Pacific Fulfillment Center
--------------	----------------------------



Includes qty 1 Medium Hard Case
Case Inside Dimensions:
20.5"W x 32.5"H x 12"D

EZ Tube® CONNECT 10FT KIT J (3'X5'X3')

PRODUCT CATEGORY: EZ FABRIC DISPLAYS

PRODUCT CODE: EZCNCT-10KIT-J-3X5X3

PARTS LIST

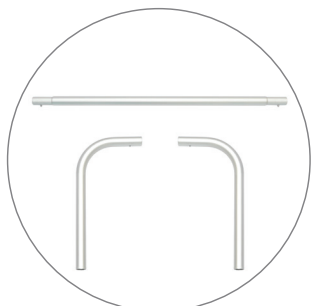

Top cross bar-3ft straight
(qty 2)

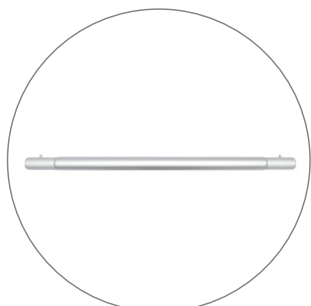

Bottom cross bar-3ft
(qty 2)

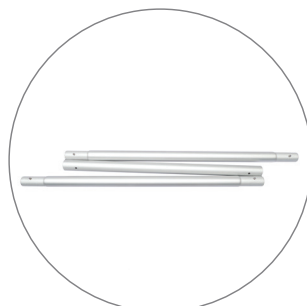

3 section 64" pole
(qty 4)

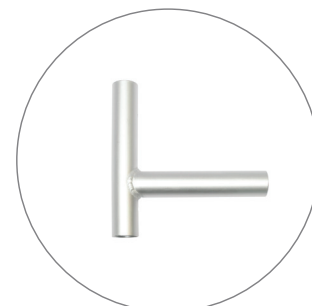

Bottom Cross Bar L shape
connector
(qty 4)

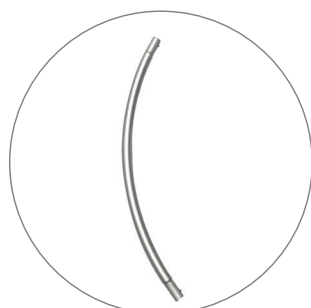

Male - Male Curved Tube
(qty 2)

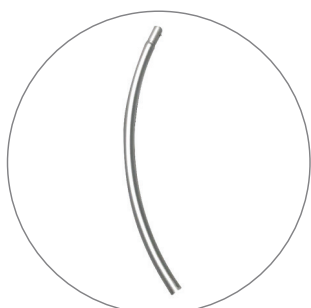

Male - Female Curved Tube
(qty 2)

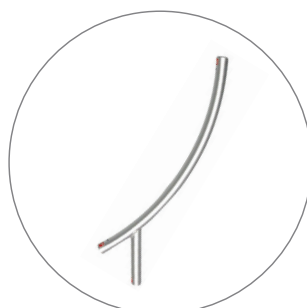

Bottom Tubes for Legs
(qty 2)

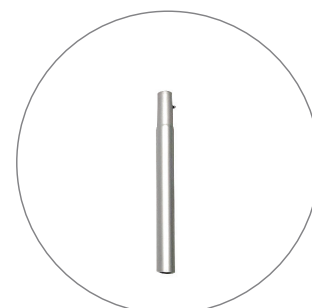

Leg Tube
(qty 2)



Single Foot (34mm)
(qty 2)



Double Foot (34mm)
(qty 2)



Soft Bag 3ft
(qty 2)



Soft Bag 5ft
(qty 1)

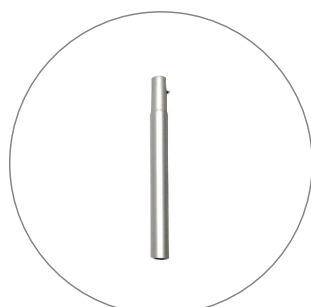

2ft Extension Tube
(qty 2)



MHC
(qty 1)

EZ Tube® CONNECT 10FT KIT K (3'X7'X3')

PRODUCT CATEGORY: EZ FABRIC DISPLAYS

PRODUCT CODE: EZCNCT-10KIT-K-3X7X3



On frame On graphic

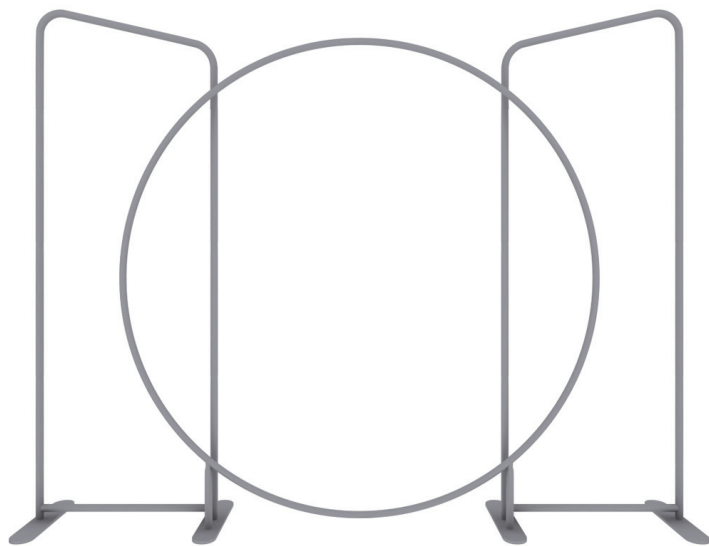

Single foot connection



Double foot connection

Foot Dims
3 1/8" x 18 3/4"

PRODUCT DESCRIPTION

Modular has officially met tube frames! EZ Tube® Connect modular tube display system lets you configure multiple shapes, sizes and frames. EZ Tube® Connect lets you choose from straight, round or slant top shapes, 90" or 96" frame heights, and 2ft, 3ft, 4ft, 5ft, 8ft and 10ft frame widths. Each EZ Tube® Connect frame easily connects, using aluminum tubing with push button snaps to lock and to attach to feet. Feet have two mounting points to connect frames side-by-side. Customize single- or double-sided stretch fabric graphics that pulls over frames and zips closed underneath. Medium Hard Case included. (Medium Hardcase Graphic optional)

DISPLAY DIMENSIONS	120"W x 90"H x 18.75"D
GRAPHIC SIZE 3FT	37"W x 89.5"H
GRAPHIC SIZE CIRCLE	84.75" W x 84.75" H
GRAPHIC SIZE MHC	62.375"W x 32.25"H

GRAPHIC MATERIAL

Stretch Fabric

GRAPHIC FINISHING

Sewn on left, right and top with zipper on the bottom

DISPLAY CONSTRUCTION

34mm Aluminum Tubing

SHIPPING WEIGHTS & DIMENSIONS

Shipping Weight	74 lbs (frames, graphics, & MHC)
Shipping Dimensions	22"W x 39"H x 17"D

LARGE QUANTITY FREIGHT

Freight Shipping	8 boxes per 48"L x 40"W x 43"H skid
Freight Weight	592 lbs (frames, graphics, & MHC)

GRAPHIC TURN AROUND TIME

2 business days after proof approval (up to 2 kits)

AVAILABILITY	Pacific Fulfillment Center
--------------	----------------------------



Includes qty 1 Medium Hard Case
Case Inside Dimensions:
20.5"W x 32.5"H x 12"D

EZ Tube® CONNECT 10FT KIT K (3'X7'X3')

PRODUCT CATEGORY: EZ FABRIC DISPLAYS

PRODUCT CODE: EZCNCT-10KIT-K-3X7X3

PARTS LIST

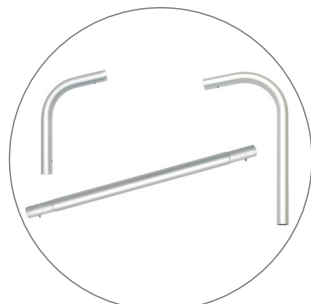

Top cross bar-3ft slope
(qty 1)

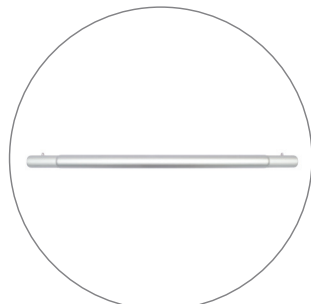

Bottom cross bar-3ft
(qty 2)

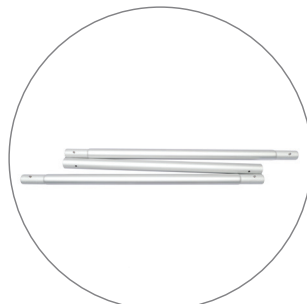

3 section 64" pole
(qty 4)



Bottom Cross Bar L shape
connector
(qty 4)



Male - Male Curved Tube
(qty 2)



Male - Female Curved Tube
(qty 5)



Bottom Tubes for Legs
(qty 2)



MHC
(qty 1)



Single Foot (34mm)
(qty 2)



Double Foot (34mm)
(qty 2)



Soft Bag 3ft
(qty 2)



Soft Bag 7ft
(qty 1)

EZ Tube® CONNECT 10FT KIT L (8'X5')

PRODUCT CATEGORY: EZ FABRIC DISPLAYS

PRODUCT CODE: EZCNCT-10KIT-L-8X5



On frame On graphic

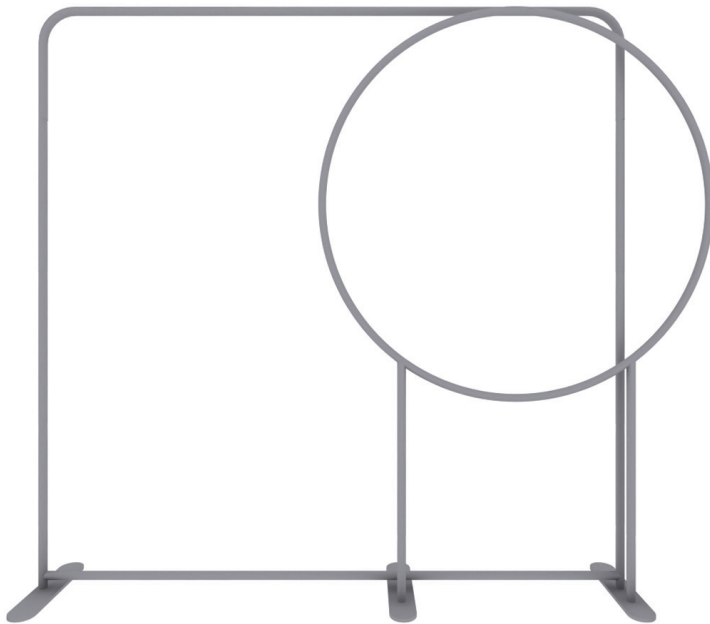

Single foot connection



Double foot connection

Foot Dims
3 1/8" x 18 3/4"

PRODUCT DESCRIPTION

Modular has officially met tube frames! EZ Tube® Connect modular tube display system lets you configure multiple shapes, sizes and frames. EZ Tube® Connect lets you choose from straight, round or slant top shapes, 90" or 96" frame heights, and 2ft, 3ft, 4ft, 5ft, 8ft and 10ft frame widths. Each EZ Tube® Connect frame easily connects, using aluminum tubing with push button snaps to lock and to attach to feet. Feet have two mounting points to connect frames side-by-side. Customize single- or double-sided stretch fabric graphics that pulls over frames and zips closed underneath. Medium Hard Case included. (Medium Hardcase Graphic optional)

DISPLAY DIMENSIONS	107.125"W x 90"H x 18.75"D
GRAPHIC SIZE 8FT	96"W x 89.5"H
GRAPHIC SIZE CIRCLE	61" W x 61" H
GRAPHIC SIZE MHC	62.375"W x 32.25"H

GRAPHIC MATERIAL

Stretch Fabric

GRAPHIC FINISHING

Sewn on left, right and top with zipper on the bottom

DISPLAY CONSTRUCTION

34mm Aluminum Tubing

SHIPPING WEIGHTS & DIMENSIONS

Shipping Weight	62 lbs (frames, graphics, & MHC)
Shipping Dimensions	22"W x 39"H x 17"D

LARGE QUANTITY FREIGHT

Freight Shipping	8 boxes per 48"L x 40"W x 43"H skid
Freight Weight	496 lbs (frames, graphics, & MHC)

GRAPHIC TURN AROUND TIME

2 business days after proof approval (up to 2 kits)

AVAILABILITY	Pacific Fulfillment Center
---------------------	----------------------------



Includes qty 1 Medium Hard Case
Case Inside Dimensions:
20.5"W x 32.5"H x 12"D

EZ Tube® CONNECT 10FT KIT L (8'X5')

PRODUCT CATEGORY: EZ FABRIC DISPLAYS

PRODUCT CODE: EZCNCT-10KIT-L-8X5

PARTS LIST



Top cross bar-8ft straight
(qty 1)



Bottom cross bar-8ft
(qty1)



3 section 64" pole
(qty 2)

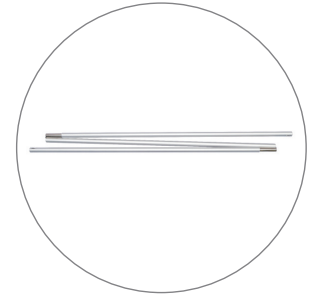

Center Vertical pole-90"
(qty 1)



Bottom Cross Bar L shape
connector
(qty 2)

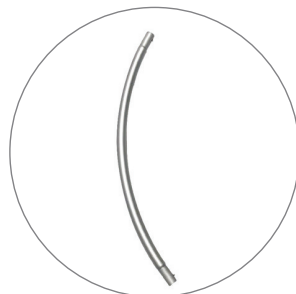

Male - Male Curved Tube
(qty 2)



Male - Female Curved Tube
(qty 2)

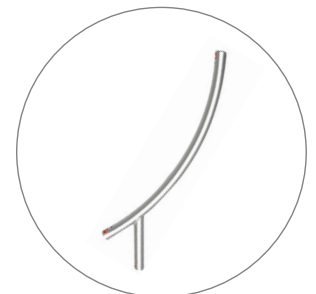

Bottom Tubes for Legs
(qty 2)



Leg Tube
(qty 2)

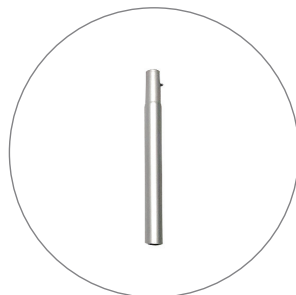

2ft Extension Tube
(qty 2)



Single Foot (34mm)
(qty 2)



Double Foot (34mm)
(qty 1)



MHC
(qty 1)



Soft Bag 5ft
(qty 1)



Soft Bag 8ft
(qty 1)

EZ Tube® CONNECT 10FT KIT M (7'X4')

PRODUCT CATEGORY: EZ FABRIC DISPLAYS

PRODUCT CODE: EZCNCT-10KIT-M-7X4



On frame On graphic

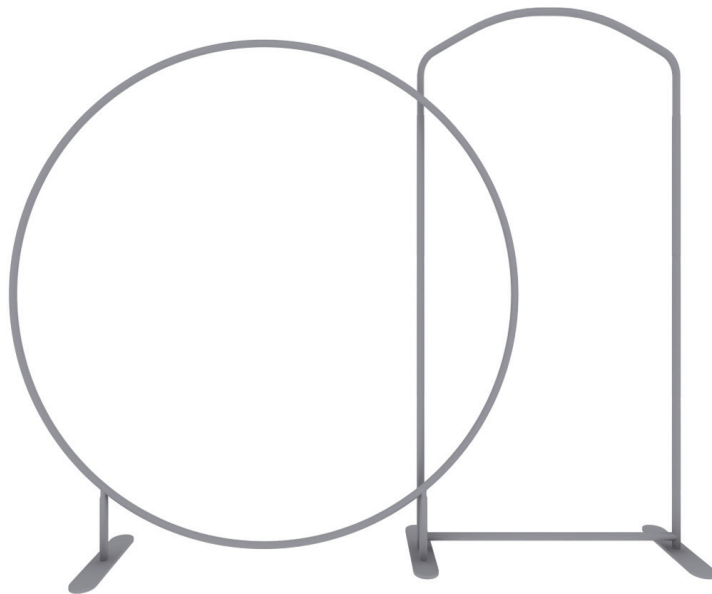

Single foot connection



Double foot connection

Foot Dims
3 1/8" x 18 3/4"

PRODUCT DESCRIPTION

Modular has officially met tube frames! EZ Tube® Connect modular tube display system lets you configure multiple shapes, sizes and frames. EZ Tube® Connect lets you choose from straight, round or slant top shapes, 90" or 96" frame heights, and 2ft, 3ft, 4ft, 5ft, 8ft and 10ft frame widths. Each EZ Tube® Connect frame easily connects, using aluminum tubing with push button snaps to lock and to attach to feet. Feet have two mounting points to connect frames side-by-side. Customize single- or double-sided stretch fabric graphics that pulls over frames and zips closed underneath. Medium Hard Case included. (Medium Hardcase Graphic optional)

DISPLAY DIMENSIONS	113.625"W x 90"H x 18.75"D
GRAPHIC SIZE 4FT	49"W x 89.5"H
GRAPHIC SIZE CIRCLE	84.75" W x 84.75" H
GRAPHIC SIZE MHC	62.375"W x 32.25"H

GRAPHIC MATERIAL

Stretch Fabric

GRAPHIC FINISHING

Sewn on left, right and top with zipper on the bottom

DISPLAY CONSTRUCTION

34mm Aluminum Tubing

SHIPPING WEIGHTS & DIMENSIONS

Shipping Weight	46 lbs (frames, graphics, & MHC)
Shipping Dimensions	22"W x 39"H x 17"D

LARGE QUANTITY FREIGHT

Freight Shipping	8 boxes per 48"L x 40"W x 43"H skid
Freight Weight	368 lbs (frames, graphics, & MHC)

GRAPHIC TURN AROUND TIME

2 business days after proof approval (up to 2 kits)

AVAILABILITY	Pacific Fulfillment Center
--------------	----------------------------



Includes qty 1 Medium Hard Case
Case Inside Dimensions:
20.5"W x 32.5"H x 12"D

EZ Tube® CONNECT 10FT KIT M (7'X4')

PRODUCT CATEGORY: EZ FABRIC DISPLAYS

PRODUCT CODE: EZCNCT-10KIT-M-7X4

PARTS LIST



Top cross bar-4ft round
(qty 1)

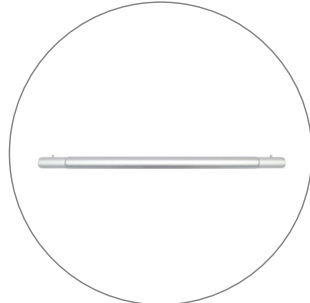

Bottom cross bar-4ft
(qty1)



3 section 64" pole
(qty 2)



Bottom Cross Bar L shape
connector
(qty 2)



Male - Male Curved Tube
(qty 2)

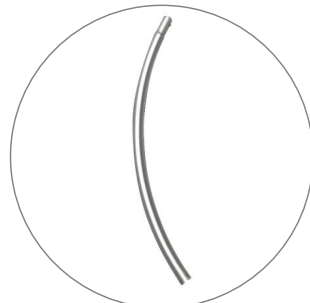

Male - Female Curved Tube
(qty 5)



Bottom Tubes for Legs
(qty 2)



MHC
(qty 1)



Single Foot (34mm)
(qty 2)



Double Foot (34mm)
(qty 1)



Soft Bag 4ft
(qty 2)



Soft Bag 7ft
(qty 1)

EZ TUBE CONNECT 2FT, 3FT, 4FT, & 5FT

PRODUCT CATEGORY: EZ FABRIC DISPLAYS
INSTRUCTIONS FOR 90" AND 96" FRAME HEIGHTS

SETUP INSTRUCTIONS

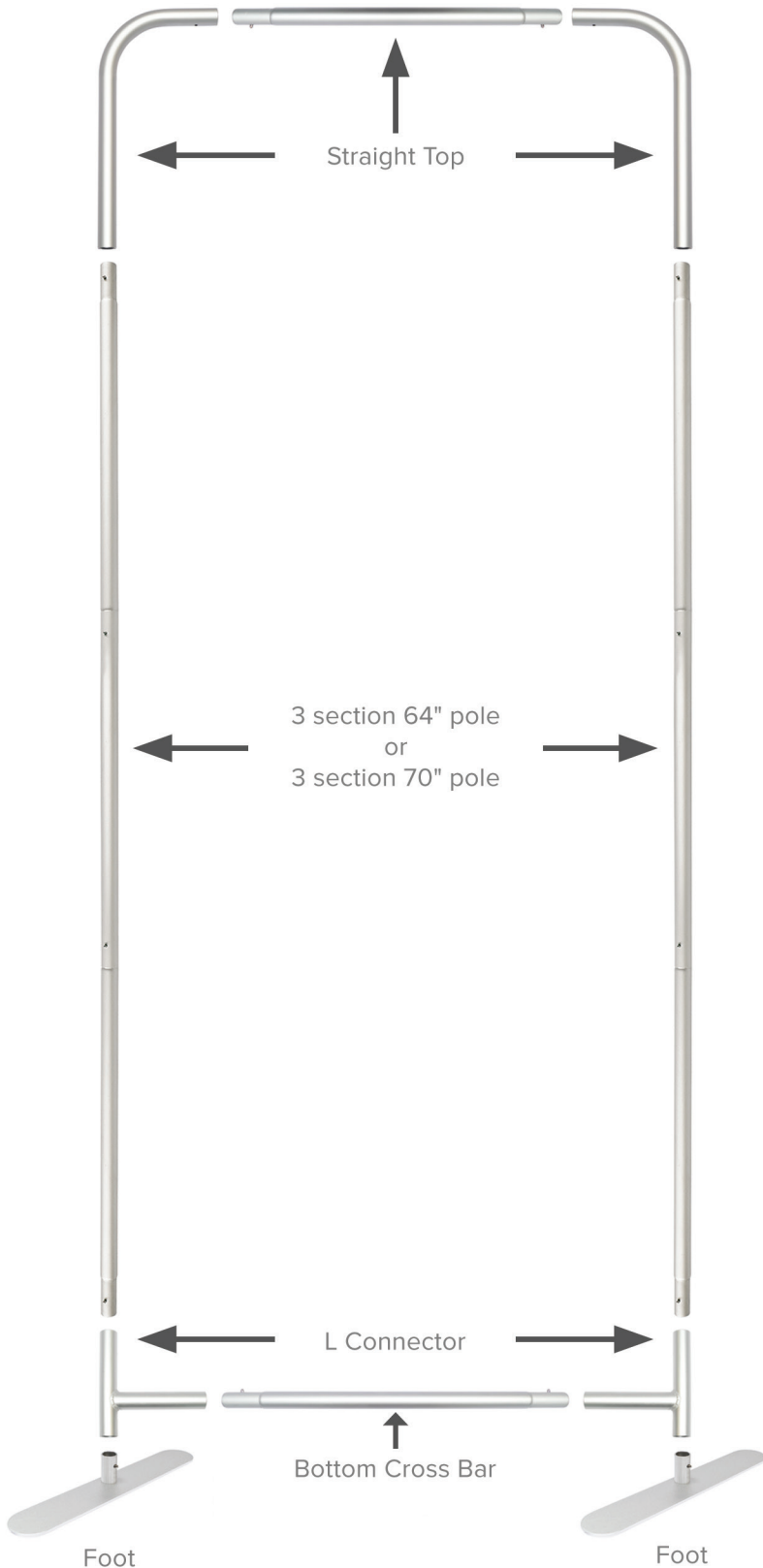

Optional top shapes for frame:

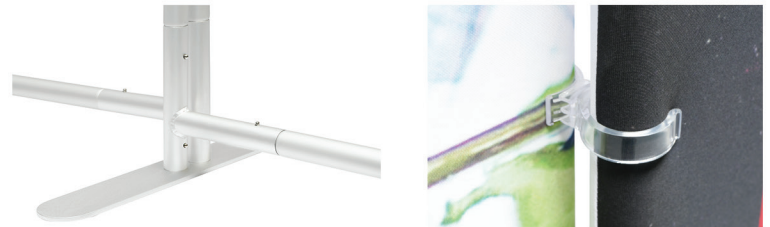

Use double foot and two connecting clips to connect frames side by side.

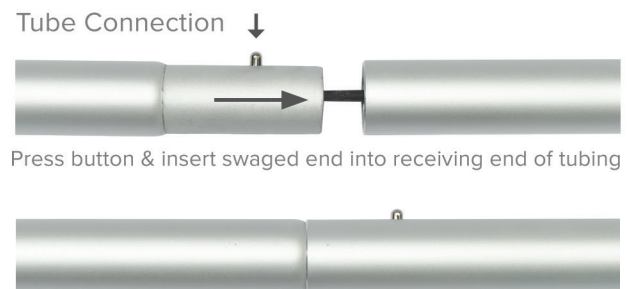

EZ Tube® CONNECT CIRCLE 5FT

PRODUCT CATEGORY: EZ FABRIC DISPLAYS

PRODUCT CODE: EZCNCT-CIR5

INSTRUCTIONS

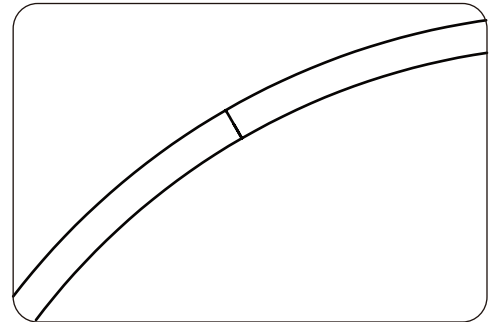
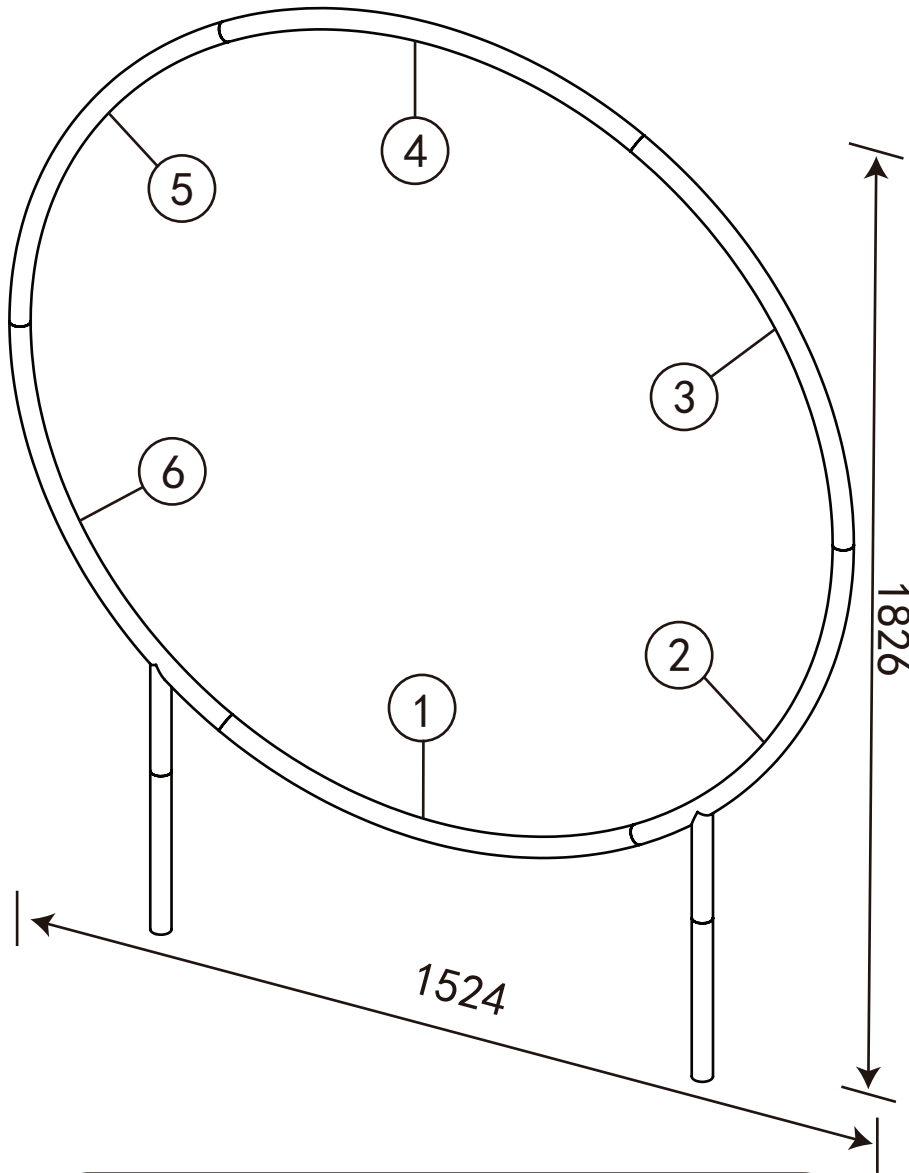

34-diameter tube, round stand,
insert connection

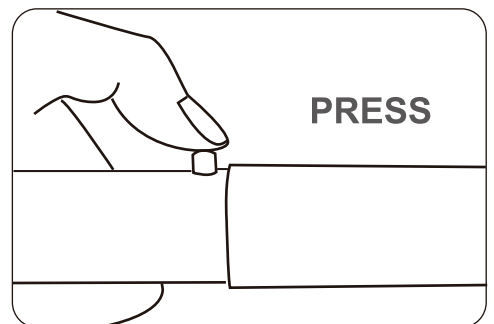
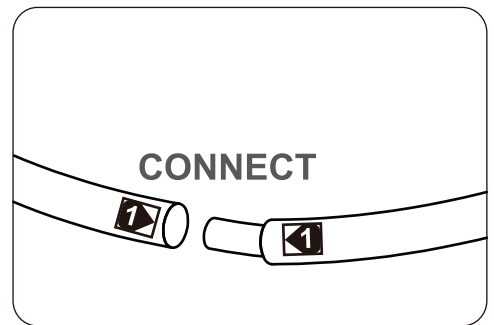

If can't snap when dismantle the frame, Pls push the tube forwardly, then push again.

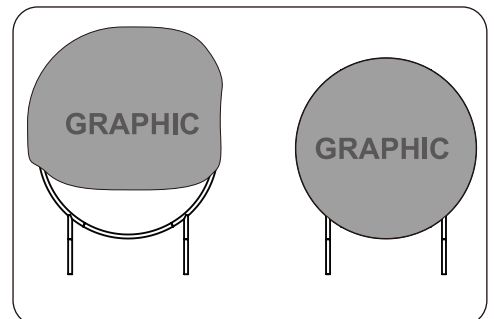
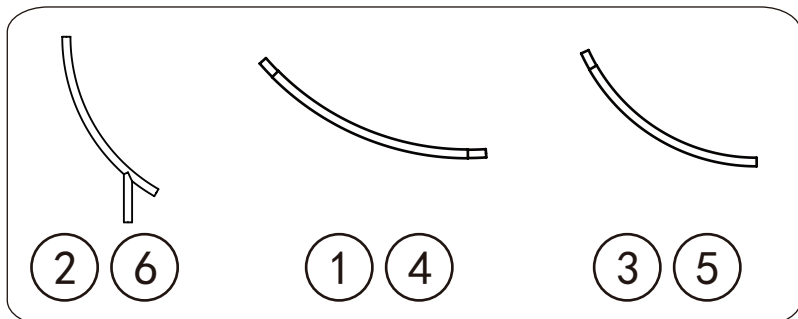

EZ Tube® CONNECT CIRCLE 7FT

PRODUCT CATEGORY: EZ FABRIC DISPLAYS

PRODUCT CODE: EZCNCT-CIR7

INSTRUCTIONS

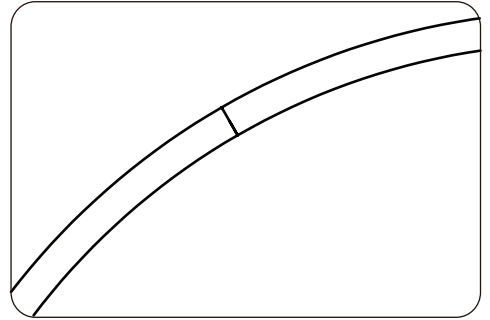
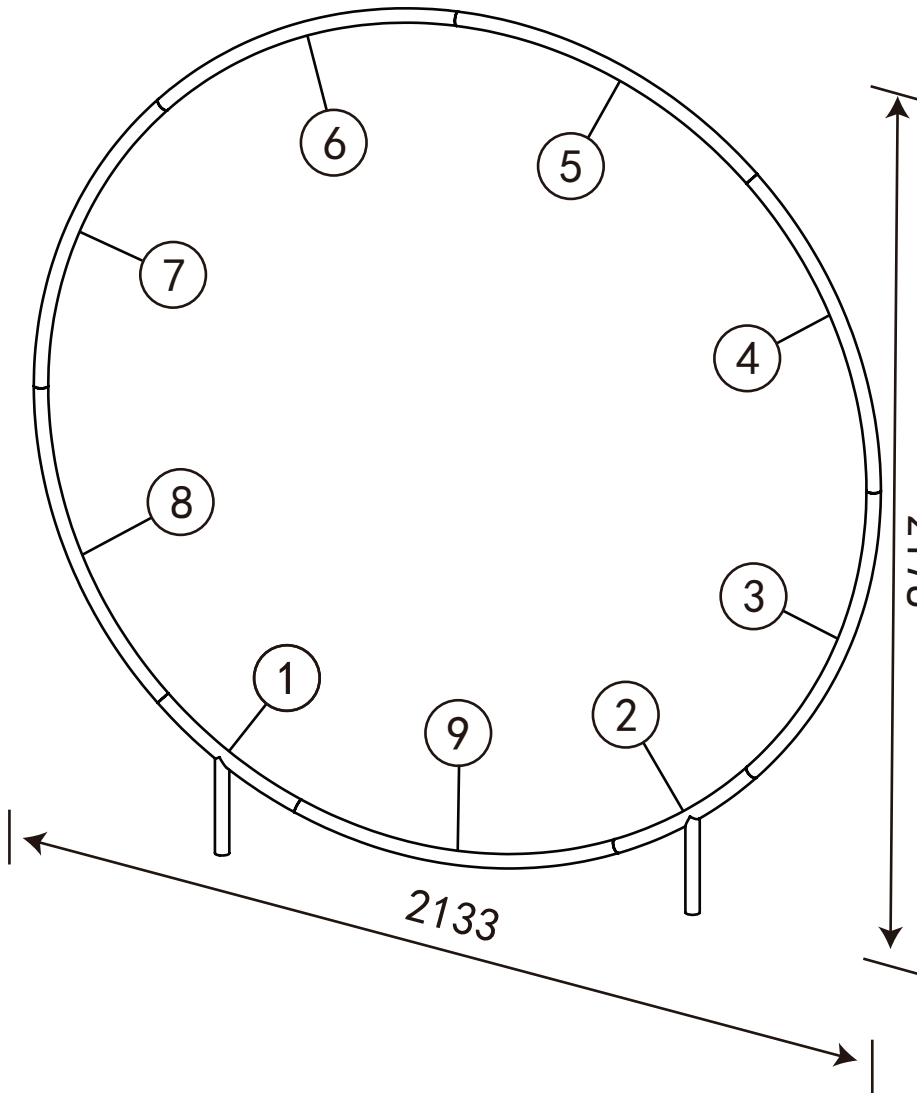

34-diameter tube, round stand,
insert connection

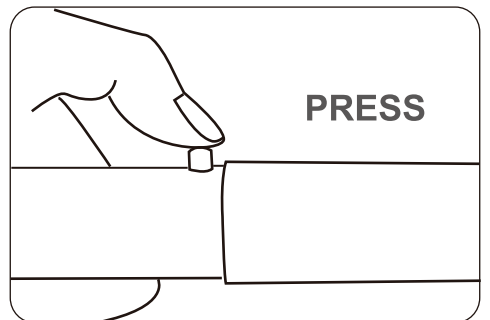
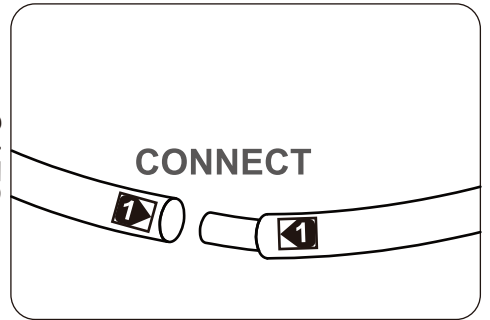

If can't snap when dismantle the frame, Pls push the
tube forwardly, then push again.

